

Operation Manual

UV INKJET PRINTER
***UCJV300* Series**
***UCJV150* Series**
Operation Manual

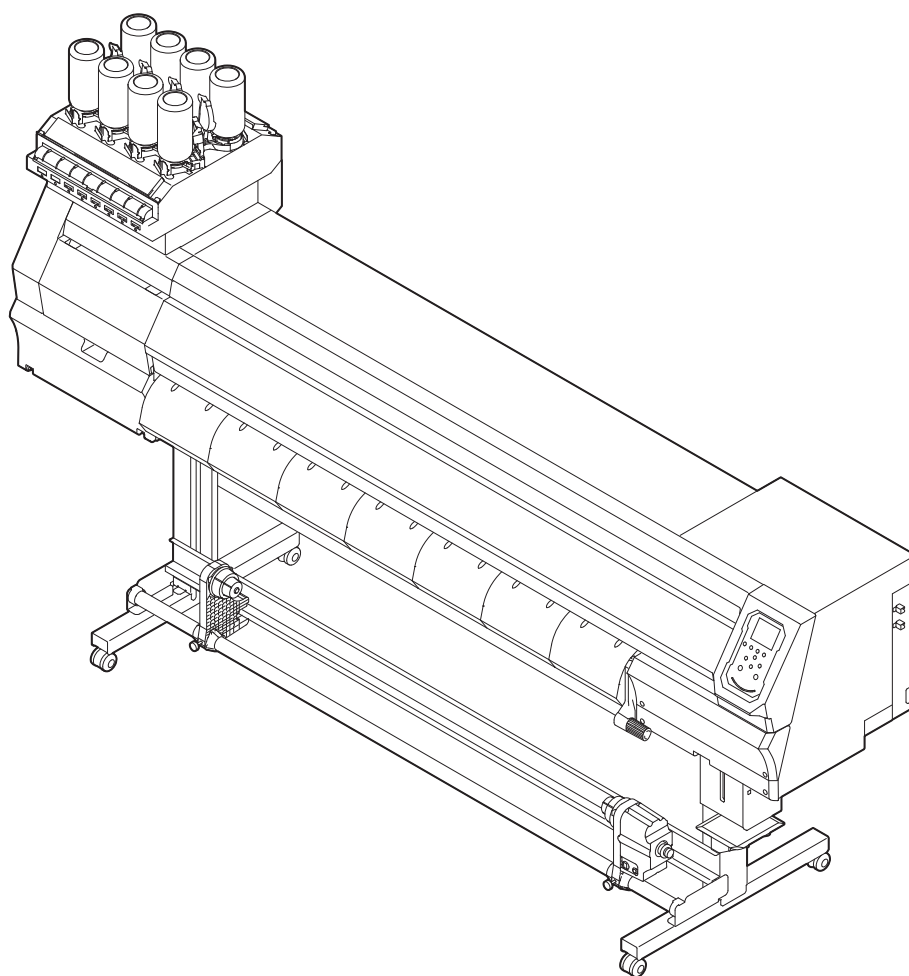

You can also download the latest manual from official website.

MIMAKI ENGINEERING CO., LTD.

<https://mimaki.com/>

D203176-26
Original instructions

TABLE OF CONTENTS

Introduction	6
For safe use	8
Symbols	8
Usage Precautions	9
Ink or any Other Liquid Used with the Machine	12
Ink Specifications	13
Restrictions concerning the product	13
Installation Precautions.....	15
Installation Space	16
When Relocating This Machine	16
Moving This Machine.....	16
Safety Interlocks	18
Warning Labels.....	19

Chapter 1 Before Using This Product

1.1 Part Names and Functions	22
Front	22
Rear and Right Side View.....	23
Carriage	24
Platen.....	24
Capping station.....	24
Pinch Rollers and Grid Rollers.....	25
Ink status lamp.....	25
Media Sensor.....	26
Take-up Unit	26
Power Supply Switch	26
Operating panel	28
1.2 Connecting the Power Cable	32
Turning On the Power.....	32
Turning Off the Power.....	33
1.3 Connecting a PC to the Product	34
Using a USB 2.0 Interface Cable	34
Using a LAN Cable	34
1.4 System Configuration	37
Driver Setup (When Using USB Cable)	37
Installing RIP Software	38
Obtaining Color Profiles	38
Setting Up RIP Software.....	40
1.5 Ink Replacement Method.....	41
When Ink Near End is Displayed	41
When Ink End is Displayed.....	41

Chapter 2 Printing

2.1 Print Process	48
2.2 Adjusting Print Head Height.....	51

2.3 Adjusting the Pinch Roller Positions	52
1,600 mm size	53
1,300 mm size	54
1,070 mm size	55
750 mm size	56
2.4 Loading the Media	57
Media	57
Loading the Roll Media	57
Setting Leaf Media	62
2.5 Setting the Pressure and Number of Pinch Rollers to Use	66
2.6 Test Printing	67
Changing the Layout Direction for Test Printing	67
Checking White Ink Ejection	67
Printing Defects	68
2.7 Head Cleaning	69
2.8 Feed Correction	70
Feed Correction Procedure	70
2.9 Correcting the Drop Position	72
Drop Position Correction Procedure	72
2.10 Printing RIP Data	73
Preparing RIP Data	73
Changing the Origin	75
Starting Printing	75
Stopping Printing (Data Clear)	76
2.11 Cut the media.	77

Chapter 3 Cutting

3.1 Cutting Process	80
3.2 Installing Cutting Tools	82
Using the Cutter	82
Using a Pen	86
3.3 Setting the Cutting Conditions	90
3.4 Test Cutting	91
3.5 Cutting the Cutting Data	92
Changing the Origin	92
Starting Cutting	92
Stopping Cutting (Data Clear)	93
Retracting the Cutter Unit	93

Chapter 4 Try cutting data with registration marks

4.1 Process for Cutting Data with Register Marks	96
--	----

4.2 Creating Register Marks	98
Register marks.....	98
Register Mark Size	99
Spacing Between Register Marks.....	99
Reading Range of Register Marks.....	100
No-Plotting Areas Around Register Marks.....	102
Combined Operations of Printing and Cutting	102
4.3 Setting Mark Detection Conditions	103
4.4 Detecting the Position of the Register Mark Origin.....	104
4.5 ID Cut Process.....	105

Chapter 5 Settings

5.1 Setup menu	108
Temporary Use	108
Setup Menu List.....	109
5.2 Maintenance Menu	113
Maintenance Menu List.....	113
5.3 Machine Setup Menu.....	117
Machine Setup Menu List	117
5.4 Nozzle Check Menu.....	122
Nozzle Check Menu List	122
5.5 Information Menu.....	123
Information Menu List	123
5.6 Cutting Menu	124
Cutting Menu List.....	124

Chapter 6 Maintenance

6.1 Maintenance Precautions	130
6.2 Daily Maintenance	131
Maintenance Items and Timing.....	131
Items Required for Maintenance.....	131
Ink Maintenance	132
Wiper Cleaning	132
Cap Cleaning	134
NCU Cleaning.....	135
Carriage Underside Cleaning	136
Cleaning the Mist Filter	138
Print Head Nozzle Washing.....	139
Ink Discharge Channel Cleaning	140
Media Sensor Cleaning	141
Media Holder Cleaning	142
Platen Cleaning	142
Cover (Exterior) Cleaning	143
When Not in Use for Extended Periods	143

6.3 Consumable Item Replacement	146
Wiper Replacement	146
Cap Absorber Replacement	147
Waste Ink Tank Replacement.....	148
Exhaust Fan Filter Replacement	151
Pinch Roller Replacement	152
Media Holder Replacement	153
Media Cutter Replacement	154
Mist Filter Replacement	155
LED Glass Replacement	156
6.4 Consumable Item Replacement (Cutting Related)	158
Pen Line Replacement	158

Chapter 7 Dealing with Problems

7.1 Troubleshooting	162
The power does not turn on.....	162
Printing is not possible.....	162
The media jams or the media is dirty.....	162
Image defects occur.	163
Ink leakage occurs.....	163
Ink colors are mixed.....	163
The light-blocking cover comes off.	167
Cutting Related	167
7.2 Problems indicated by messages	172
Warning messages	172
Ink errors (local guidance)	174
Error messages	175
SYSTEM HALT	181

Chapter 8 Appendix

8.1 Specifications.....	184
8.2 Specifications (Cutting).....	187
8.3 LICENSE Library	188

Introduction

Thank you for purchasing the UV-LED curable inkjet printer UCJV300 Series, 150 Series.

Read this operating manual ("this document" hereinafter) thoroughly and make sure you understand its contents to ensure safe and correct use of the product.

Please note that the illustrations contained in this manual are intended to show functions, procedures, or operations and may sometimes differ slightly from the actual machine.

Adobe, the Adobe logo, Acrobat, Illustrator, Photoshop, and PostScript are the trademarks or registered trademarks of Adobe Incorporated in the United States and other countries.

Other company and product names mentioned herein are the trademarks or registered trademarks of the respective companies in Japan and in other countries.

RasterLink and FineCut are the trademarks or registered trademarks of MIMAKI ENGINEERING CO., LTD. in Japan and in other countries.

Unauthorized reproduction of any portion of this document is strictly prohibited.

© 2017 MIMAKI ENGINEERING Co., Ltd.

● Disclaimers

- Mimaki Engineering accepts no liability for damages arising directly or indirectly from the use of the UCJV300 Series, 150 Series ("this product" hereinafter), whether or not the product is faulty. Mimaki Engineering rejects all liability for damages, direct or indirect, resulting from the use of this product.
- Mimaki Engineering rejects all liability for damages, direct or indirect, attributable to materials created while using this product.
- Using this product in conjunction with devices other than those recommended by Mimaki Engineering may result in fire or accidents. Such incidents are not covered by the product warranty. Mimaki Engineering rejects all liability for damages, direct or indirect, arising from such incidents.
- Use only genuine Mimaki Engineering ink and maintenance cleaning solution. Use of other products may result in failures or reduce print quality. Such incidents are not covered by the product warranty. Mimaki Engineering rejects all liability for damages, direct or indirect, arising from such incidents.
- Do not attempt to refill the ink bottles with unauthorized ink. Disregarding this precaution will void the warranty. Mimaki Engineering rejects all liability for damages, direct or indirect, arising from such incidents.
- Use only genuine Mimaki Engineering anti freezing liquid. Use of other anti freezing liquid may cause failures or reduce print quality. Disregarding this precaution will void the warranty. Mimaki Engineering rejects all liability for damages, direct or indirect, arising from such incidents.
- Avoid using UV-LED units or UV power supply units other than those specified by Mimaki Engineering. Using devices other than genuine Mimaki Engineering devices may result in failure, electric shock, or fire. Such incidents are not covered under the warranty. Mimaki Engineering rejects all liability for damages, direct or indirect, arising from such incidents.

● TV and radio interference



- This product emits high-frequency electromagnetic radiation while operating. Under certain circumstances, this may result in TV or radio interference. We make no guarantee that this product will not affect special radio or TV equipment.
-

If you suspect that this product is causing radio or TV interference, check by powering off this product. If the interference disappears when the power is turned off, this product is likely to be the cause of the interference.

Try any of the following solutions or combinations of these solutions:

- Change the orientation of the TV or radio antenna to find a position where interference does not occur.
 - Move the TV or radio away from this product.
-

- Plug the TV or radio into a power outlet on a power circuit other than the power circuit to which this product is connected.

● FCC (Federal Communications Commission) regulations

This product has been tested and certified to comply with restrictions applying to Class A digital devices under Part 15 of the FCC regulations. These restrictions are designed to provide suitable protection from harmful interference when the printer is used in commercial environments.

This product may generate, use, or emit radio frequency energy and may cause harmful interference with radio communications if not installed or used in accordance with the operating manual.

Use of this product in residential areas may cause harmful interference. If so, the user is responsible for rectifying such interference.











- Use only the cables recommended by Mimaki Engineering when connecting to this product. Use of other cables may cause the product to exceed the restrictions stipulated by FCC regulations. To maintain compliance with FCC regulations, use the cables recommended by Mimaki Engineering.
-

For safe use

Symbols

In this manual, the symbols indicate and explain precautions. Make sure you fully understand the meaning of each symbol and use the machine safely and correctly.

Explanation		
	Warning	Indicates a potential hazard that may result in death or serious injury if handled improperly or if instructions are disregarded.
	Caution	Indicates a potential hazard that may result in minor or moderate injury if handled improperly or if instructions are disregarded.
	Notice	Indicates a potential hazard that may result in property damage if handled improperly or if instructions are disregarded.
	Warning sign	Indicates something that requires attention. Warning specifics are drawn inside the symbol.
	Mandatory action sign	Indicates an action that must be carried out. The specifics of the mandatory action are drawn inside the symbol.
	Prohibition sign	Indicates a prohibited action. The specifics of the prohibited action are drawn inside the symbol.
	Important	Indicates important information related to use of this product.
	Tip	Indicates useful reference information.
	Reference information	Indicates the corresponding page for related information. Click the text to display the corresponding page.

Usage Precautions

● In the event of abnormal conditions

WARNING



- In the event of abnormal conditions such as smoke or unusual odor, turn off the main power immediately and unplug the power cable. Continuing to use the product under these conditions may result in failure, electric shock, or fire. Once you have confirmed that smoke is no longer being emitted, contact your local dealer or our service office. Never attempt to repair the product yourself. Doing so is hazardous.

CAUTION



- Immediately wipe off any ink, maintenance washing liquid, waste ink, or other liquid used with the product that comes into contact with your skin. Wash using soap. Rinse with plenty of water. Failure to wash off liquid may result in skin inflammation. If your skin becomes irritated or painful, seek medical attention immediately.
- If ink, maintenance washing liquid, waste ink, or any other liquid used in the product comes into contact with your eyes, rinse immediately with plenty of clean water. Rinse for at least 15 minutes. If you wear contact lenses and they can be easily removed, remove after rinsing for at least 15 minutes with clean water. Be sure to rinse the undersides of your eyelids. Failure to rinse off liquid may result in blindness or impaired vision. If your eyes become irritated or painful, seek medical attention immediately.
- If ink, maintenance washing liquid, waste ink, or any other liquid used in the product enters your mouth or is swallowed, gargle with water immediately. Do not induce vomiting. Seek medical attention promptly. Inducing vomiting may cause liquid to enter the airway.
- If a large amount of vapor is inhaled, move to a well-ventilated area, keep warm, and rest in a posture that allows easy breathing. If the condition does not improve, seek medical attention promptly.

NOTICE



- If an ink leak occurs, turn off the main power immediately and unplug the power cable. Contact your local dealer or our service office.

● Power supply precautions

WARNING



- Use the power cable provided. Using other cables may result in failure, electric shock, or fire. Do not use the power cable with other electronic devices.
- Always grasp the plug when unplugging the power cable. Pulling on the power cable itself may damage the cable and result in failure, electric shock, or fire.
- Do not use the power plug with dust on it. Using the power plug under these conditions may result in failure, electric shock, or fire.
- Avoid touching the blade of the power plug with a metal object. Disregarding this precaution may result in machine failure, electric shock, or fire.
- Do not attempt to modify the cable. Avoid damaging the cable. Avoid placing heavy objects on the power cable or pulling on or exposing the cable to heat. Doing so may damage the cable, resulting in fire or electric shocks.
- Do not use extension cords or multi-outlet extension cords. Doing so may result in machine failure, electric shock, or fire.
- Do not use if the power cable appears to be damaged or the core wire has an exposed or broken core. Disregarding this precaution may result in machine failure, electric shock, or fire.



- Do not plug/unplug the power plug with wet hands. Disregarding this precaution may result in electric shock.



- Plug the power cable plug into a grounded power outlet. Disregarding this precaution may result in machine failure, electric shock, or fire.
- When installing electrical outlets, perform grounding work to prevent electric shock. All electrical work must be done by a licensed electrician.
- Perform grounding work.

NOTICE



- Do not turn off the main power supply. Turning off the main power supply will disable the automatic maintenance function (including nozzle clogging prevention function and ink discharge channel cleaning function) and may result in printing defects (such as nozzle clogging and deflection) or other faults.

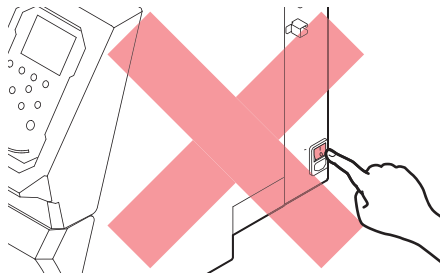

- Use this product with a power supply that meets specifications.
- Be sure to plug the power cable into a power outlet close to the product. Insert the power plug blade securely.
- When connecting the power cable, check the input voltage of the power outlet and the capacity of the breaker. Also, connect each cable to a separate power source with an independent breaker. Connecting to power outlets linked with the same breaker may trip the breaker.

● Caution regarding moving parts

CAUTION



- Keep parts of the body such as the face and hands and clothing (e.g., loose clothing and accessories) that may impede work away from the machine. Failure to do so may result in injury. Long hair should be tied back.

● Do not disassemble or repair

WARNING



- Do not attempt to disassemble or repair this machine. Disregarding this precaution may result in fire, electric shock, or fire.

● Precautions when handling the cutter

CAUTION



- Do not touch the cutter blade. Disregarding this precaution may result in injury.

● Precautions when handling the cutter for cutting media

CAUTION



- Avoid touching the cutter blade. Doing so may lead to injury.
- Do not shake or swing the cutter holder. Doing so may cause the blade to come off.

● Precautions for ultraviolet (UV) light and the UV-LED unit

WARNING



- Do not place combustible materials underneath the UV-LED unit. Disregarding this precaution may result in fire or smoldering.
- Do not cover the UV-LED unit with paper or cloth. Disregarding this precaution may result in fire or smoldering.



- Small amounts of ultraviolet light may leak from around the UV-LED unit. Take precautions to avoid exposing the skin and eyes to ultraviolet light. Wear gloves, long-sleeved clothing, face shields, and UV safety glasses.
 - (1) Exposure to UV light may result in skin inflammation. Even if no inflammation occurs, extended or repeated exposure may lead to chronic problems.
 - Acute problems: Inflammation
 - Chronic problems: Skin cancer, wrinkles, blotches
 - (2) Looking directly at the lamp while the lamp is on may result in eye pain or damage to eyesight. Even if no eye pain occurs, extended or repeated exposure may lead to chronic problems.
 - Acute problems: Ultraviolet keratitis, conjunctivitis, discomfort, pain, watery eyes
 - Chronic problems: Pterygium, cataracts

CAUTION



- The UV-LED unit becomes extremely hot. Turn off the LED and wait for the unit to cool before attempting maintenance work.



- Do not expose the skin or eyes directly or indirectly to light from the UV-LED unit. The UV-LED unit emits ultraviolet (UV) light. Exposure may result in skin or eye inflammation.



- Use only the UV safety glasses provided. Disregarding this precaution may result in eye pain or damage to eyesight.

NOTICE



- Avoid scratching or subjecting the UV-LED unit to excessive force. Disregarding this precaution may result in failure.
- Avoid touching the glass on the underside of the UV-LED unit with bare hands. Disregarding this precaution may impair UV ink curing. If the glass becomes dirty, wipe clean using a soft, clean cloth moistened with ethanol. Be careful to keep ethanol from splashing on the covers while cleaning. Contact with ethanol may damage the covers.

● Disposing of the product

CAUTION



- Please contact your local retailer or service agent.
- If you intend to dispose of the product yourself, contact an industrial waste disposal operator or dispose of the product in accordance with local laws and regulations.

Ink or any Other Liquid Used with the Machine

Precautions regarding ink are indicated on the Ink bottle. Thoroughly read them and make sure you understand the contents.

⚠ WARNING



- Take steps to prevent leakage into natural water systems or domestic wastewater. Some constituents are toxic to aquatic life.

⚠ CAUTION



- Be sure to read the safety data sheet (SDS) before use.
<https://mimaki.com/supply/sds/>



- Wear safety glasses, gloves, and a mask when handling ink, maintenance cleaning solution, waste ink, or other solutions used with this machine. Leaking ink may adhere to the skin or get into your eyes or mouth.



- Do not subject Ink bottle to strong shocks or violent shaking. Do not attempt to refill the ink. Leaking ink may adhere to the skin or get into your eyes or mouth.



- Do not disassemble Ink bottle. Leaking ink may adhere to the skin or get into your eyes or mouth.



- Do not store in places accessible to children.



- When disposing of the product, contact an industrial waste disposal operator or dispose of the product in accordance with the local laws and regulations.

NOTICE



- Do not use ink, maintenance cleaning solution, or other liquids used with this machine with other printers. Disregarding this precaution may result in damage to the printer.
- Avoid touching or soiling the PCB contact area of the ink IC chip. Doing so may damage the PCB.



- Store in a low place no higher than 1 m above the floor. Dropping this machine may result in splashing ink, washing liquid, or other liquid.
- Store in sealed containers.
- Store in a cool and dark place.
 - (1) When moving ink from cold to warm locations, allow to stand for at least three hours in the location where it will be used. Note that using thawed ink will affect printing quality due to ink deterioration. Store ink in an environment where it will not freeze.
 - (2) Open the ink before use and use up as quickly as possible. Print quality may degrade if the bottles are left open for extended periods.



- The device will not work with different types of ink chips.
- Ink bottles may become indented even when they are mounted in the product. This will not affect function.

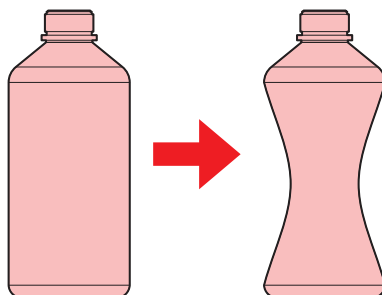

Ink Specifications

Item		Details
Type		UV curing ink (MIMAKI product)
Color		Cyan (C) Magenta (M) Yellow (Y) Black (K) Light cyan (Lc) ^{*1} Light magenta (Lm) ^{*1} White (W) ^{*1} Clear ink (CL) ^{*1}
Form		Bottle
Ink capacity		1,000 ml
Expiration		As indicated on the ink bottle However, within three months after opening, even before the expiration date
Storage temperature	When stored	5°C to 30°C (daily mean temperature) However, not more than 1 month at 30°C • Ink quality may deteriorate if stored outside these conditions.
	During transportation	1°C to 60°C However, not more than 120 hours at 60°C and not more than 1 month at 40°C • Where possible, avoid storing in cold locations below 0 °C and hot locations above 40 °C. • Ink quality may deteriorate if stored outside these conditions.

*1. 300 series only

Restrictions concerning the product

The ink expiration date is indicated on the Ink bottle. Expired ink may cause printing defects or alter the color tone. Printing is possible even if the ink has passed its expiration date. Nevertheless, we recommend replacing with new ink or use up as quickly as possible.

Example: The expiration date is April 2020

May: Replace with new ink or use up as quickly as possible. Printing is possible.

June (Yellow LED illuminated): Replace with new ink or use up as quickly as possible. Printing is possible.

July (Red LED flashing): Printing is not possible.



- The message appears on the display.
-

Installation Precautions

WARNING



- Do not install this machine in environments where flammable substances are present (e.g., gasoline, flammable spray, alcohol, thinner, lacquer, powder). This machine is not explosion-proof. The product poses a risk of explosion.



- Do not install this machine in locations where open flames are present. The ink may ignite.
- Do not place vases, pot plants, cups, cosmetics, containers of chemicals or water, or small metal objects on top of this machine. Entry into the machine of liquids or metal objects may result in malfunctions, electric shock, or fire.



- Do not install this machine in humid locations or locations where it may be exposed to splashing water. Disregarding this precaution may result in machine failure, electric shock, or fire.



- Keep children away from this machine.

CAUTION



- A ventilation system must be provided if this machine is installed in a poorly ventilated area or sealed room.
- Note the following points when installing an extractor outlet:
 - (1) The extractor outlet must be installed in accordance with applicable local EHS (environmental, health, and safety) guidelines.
 - (2) If the extractor outlet is fitted with a shutoff valve, the valve must be open when this machine is in use.

NOTICE



- Do not install this machine in locations where dust or powder is present. Failure or printing defects may result (e.g., nozzle clogging, deflection) if dust gets inside this machine.
- Do not install this machine in locations exposed to drafts (e.g., from air conditioning). Disregarding this precaution may result in dust or powder getting inside this machine.
- Do not install this machine in unstable locations or locations subject to vibration. Disregarding this precaution may result in failure or printing defects (e.g., nozzle clogging, deflection).
- Do not install this machine in locations exposed to direct sunlight.
- Do not install this machine in locations subject to sudden temperature changes. Disregarding this precaution may result in printing defects (e.g., nozzle clogging, deflection).
- Do not install this machine in locations exposed to excessive noise from large machinery.



- Permissible operating conditions: 20 °C to 30 °C (68 °F to 86 °F), 35 %RH to 65 %RH (no condensation)
- Guaranteed accuracy temperature range: 20 °C to 25 °C (68 °F to 77 °F)

Installation Space

Provide the following space around the machine to allow safe and proper replacement of ink and media:

Item	UCJV300-160	UCJV300-130	UCJV300-107	UCJV300-75	UCJV150-160
Width ^{*1}	At least 3,900 mm (2,900 mm)	At least 3,650 mm (2,650 mm)	At least 3,380 mm (2,380 mm)	At least 3,090 mm (2,090 mm)	At least 3,900 mm (2,900 mm)
Depth ^{*1}	At least 2,776 mm (776 mm)				
Height ^{*1, *2}	(1,475 mm)				
Weight	188 kg	177 kg	161 kg	144 kg	183 kg

*1. The figures in parentheses indicate machine dimensions.

*2. Excluding ink bottle height.

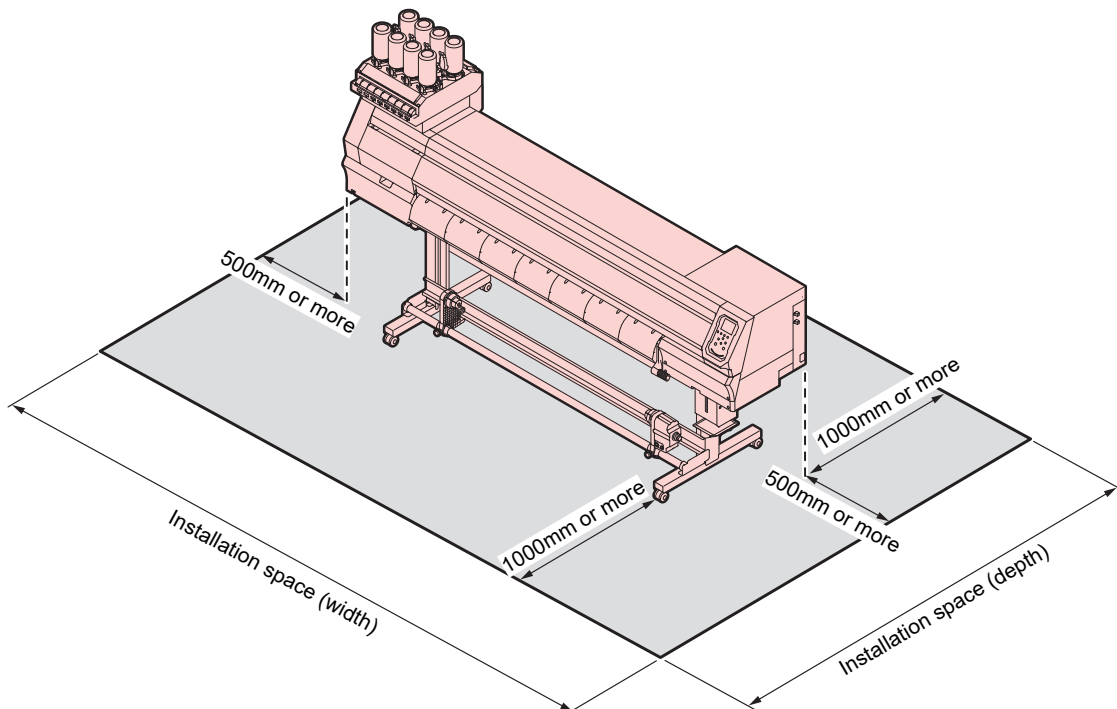

When Relocating This Machine

Contact your local dealer or our service office. Attempting to handle relocation yourself may result in failure or damage.

Moving This Machine

Never move this machine. If circumstances make it unavoidable, move the machine only to a location somewhere on the same floor horizontally.



- Read and make sure you fully understand the procedures before moving this product.



- Do not press the cover when moving. The cover may be damaged.

- 1 Attach the transportation stays fitted underneath this product.
- 2 Remove the caster block.

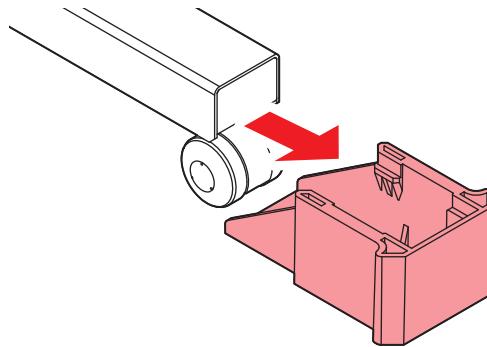



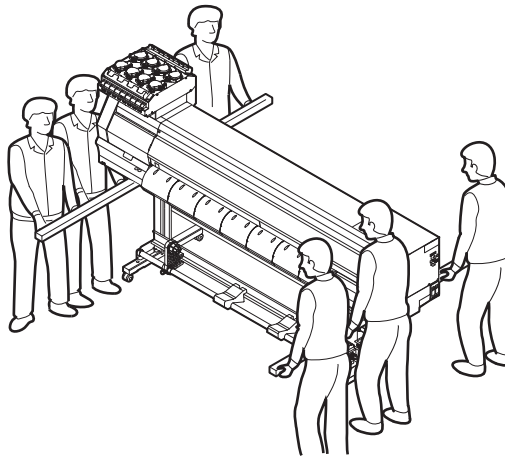

- 3 Move by grasping the transportation stays.

- Assign at least six persons to move this product. Comply with local regulations when moving the product.

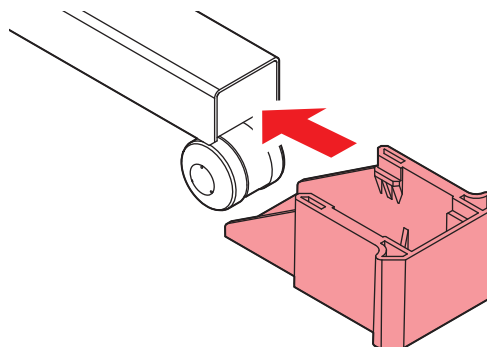

- 4 Replace the caster block.



- 5 Remove the transportation stays.
- 6 Attach transport stay to the underside of the main unit.
- 7 Check the following:
 -  "Test Printing"(P. 67)
 -  "Feed Correction"(P. 70)
 -  "Correcting the Drop Position"(P. 72)

Safety Interlocks

This machine is equipped with interlocks to ensure safety during use.

Printing will abort if you open the covers while printing is underway. If so, you will need to resend the RIP data.

- Safety interlock locations

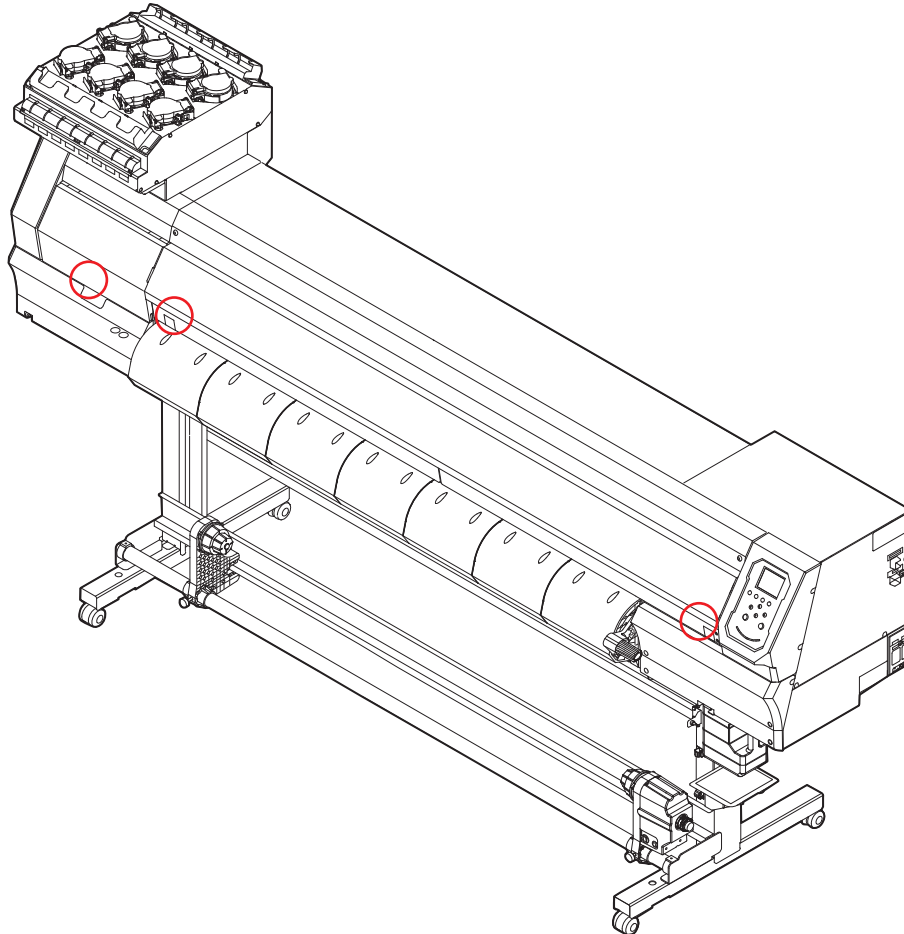





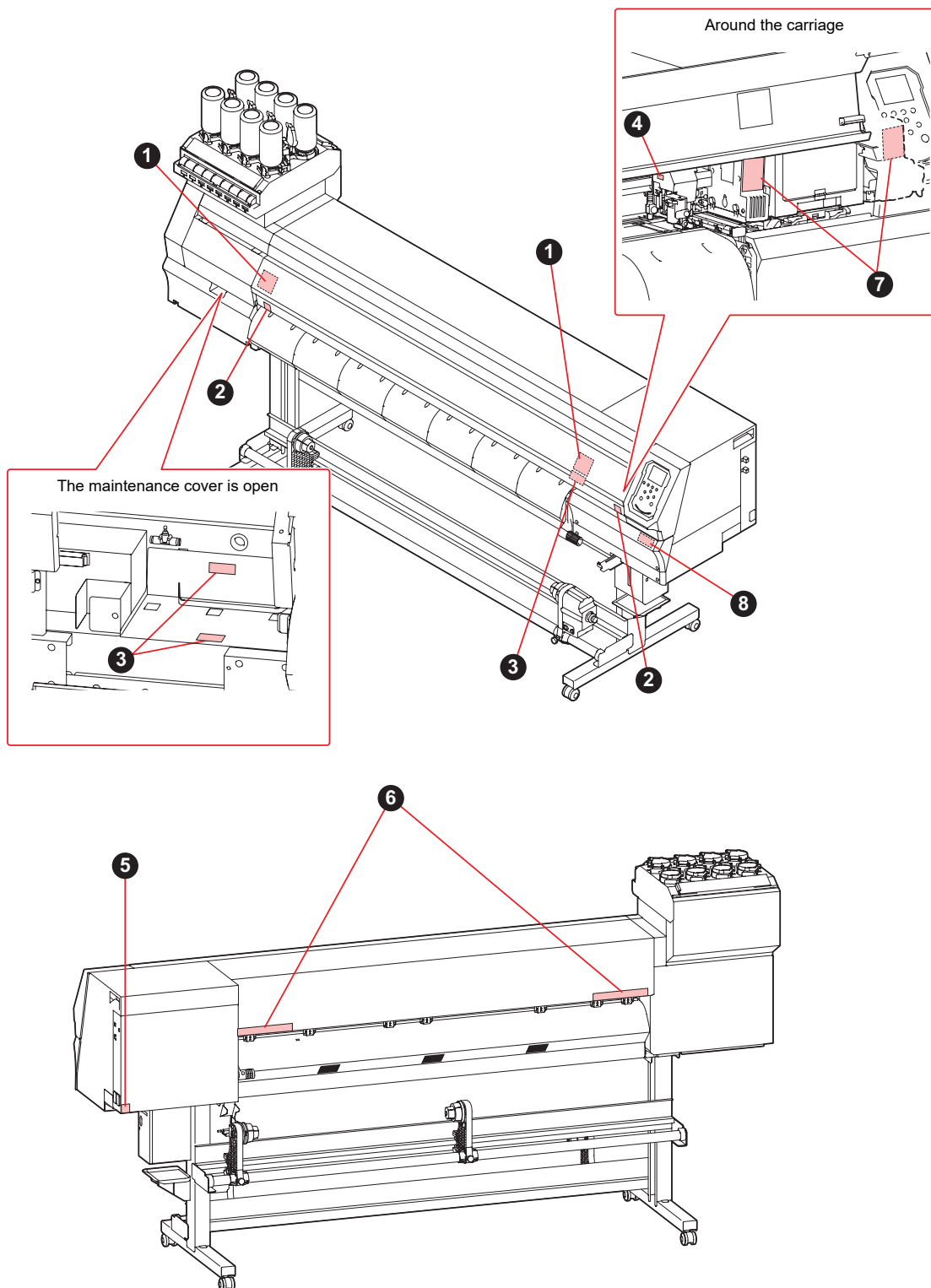

Warning Labels

Make sure you fully understand the details indicated on the various warning labels.

If any of the warning labels becomes dirty and illegible or peel off, contact your local dealer or our service office to request new warning labels.

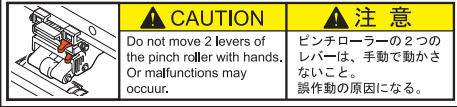

No.	Order code	Label	Details
1	M910931	 <p>CAUTION ATTENTION</p> <p>COVER HAZARD May result in severe injury. When open and close the cover, hold a cover until the end.</p> <p>COUVERCLE-DANGER Peut entraîner de graves blessures. Lors de l'ouverture ou de la fermeture du couvercle, tenir le couvercle jusqu'à la fin.</p> <p>カバー急落下あり 指を挟まると、ケガや骨折の恐れあり。 カバーの開閉は、最後まで手を添えて行ってください。</p> <p>M910931</p>	Beware of opening and closing parts. Injury may result if hands become trapped.
2	M907833		Indicates dangerous moving parts.
3	M903330		Wear safety glasses and gloves while working.
4	M903405		Beware of the cutter.
5	M907935		Indicates dangerous live parts.
6	M905811		Indicates dangerous moving parts.
7	M913419		Beware of ultraviolet light.
8	M905935		Avoid touching the pinch roller lever.

Chapter 1 Before Using This Product



This chapter

This chapter describes various parts and provides important information. Read this chapter before using the product.

Part Names and Functions	22	Connecting the Power Cable.....	32
Front.....	22	Turning On the Power.....	32
Rear and Right Side View	23	Turning Off the Power	33
Carriage	24	Connecting a PC to the Product.....	34
Platen	24	Using a USB 2.0 Interface Cable	34
Capping station	24	Using a LAN Cable	34
Pinch Rollers and Grid Rollers	25	System Configuration	37
Ink status lamp	25	Driver Setup (When Using USB Cable)	37
Media Sensor	26	Installing RIP Software.....	38
Take-up Unit.....	26	Obtaining Color Profiles	38
Power Supply Switch	26	Setting Up RIP Software	40
Operating panel.....	28	Ink Replacement Method	41
		When Ink Near End is Displayed	41
		When Ink End is Displayed	41

1.1 Part Names and Functions

Front

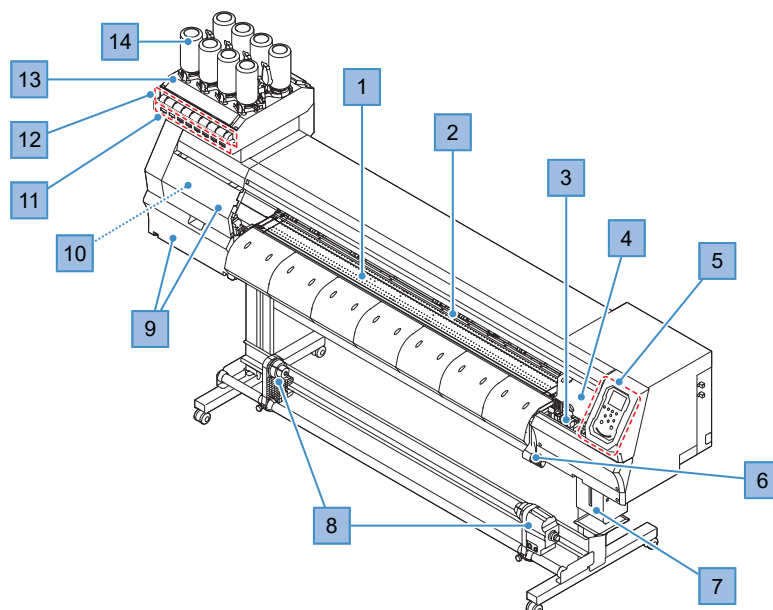

No.	Name	Summary
1	Platen	Print area. "Platen"(P. 24)
2	Pinch rollers Grid rollers	The pinch rollers and grid rollers are used to grip and feed the media. "Pinch Rollers and Grid Rollers"(P. 25)
3	Capping station	Includes caps, wipers, and an NCU for monitoring print head nozzle conditions. "Capping station"(P. 24)
4	Carriage	Consists of a print head, a UV-LED lamp, and the jam sensor. "Carriage"(P. 24)
5	Operating panel	Includes operating keys and displays indicating various settings and other items. "Operating panel"(P. 28)
6	Clamp lever (front)	Lowering the clamp lever secures the media. Raising the clamp lever releases the media.
7	Waste ink tank	Container for waste ink. "Waste Ink Tank Replacement"(P. 148)
8	Take-up unit	Automatically rolls up the roll media after printing. "Take-up Unit"(P. 26)
9	Maintenance covers	Open the cover to perform maintenance. Printing and automatic maintenance are not possible while the covers are open.
10	Cutter unit	Includes a media cutter cutting the media along the platen cutting slot. The cutter unit is located at the maintenance position on the left side during standby. "Installing Cutting Tools"(P. 82)
11	Ink IC chip slot	The ink IC chip provided with the Ink bottle is inserted here. This manages information on the Ink bottle. Insert Ink IC Chip
12	Ink status lamp	This lamp indicates ink status. "Ink status lamp"(P. 25)
13	Ink wipe filter	Filter for soaking up ink droplets from special ink bottle caps
14	Ink supply unit	The ink bottle is inserted here to supply ink to the print head. "Ink Replacement Method"(P. 41)

Rear and Right Side View

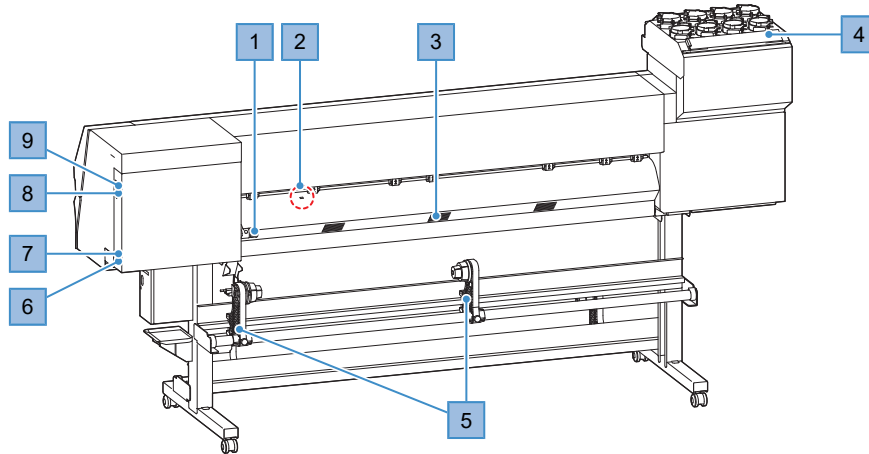

No.	Name	Summary
1	Clamp lever (rear)	Linked to the clamp lever at the front.
2	Media sensor	Detects whether media is present. "Media Sensor"(P. 26)
3	Media vacuum exhaust port	Vacuum exhaust port securing media under vacuum pressure
4	Ink wipe filter	Filter for soaking up ink droplets from special ink bottle caps
5	Feed unit	Holds the roll media before printing. Compatible with 2-inch and 3-inch paper rolls
6	AC inlet	Used to connect the power cable (provided). "Connecting the Power Cable"(P. 32)
7	Main power supply switch	Main power supply for the product To prevent print defects attributable to the print head (e.g., nozzle clogging, deflection), do not turn off the main power supply. "Turning On the Power"(P. 32) "Connecting the Power Cable"(P. 32)
8	LAN port	Used when using the network function "Using a LAN Cable"(P. 34)
9	USB port	Connects to PC via a USB interface cable. "Using a USB 2.0 Interface Cable"(P. 34)

Carriage

The carriage includes a print head for ejecting ink, a UV-LED lamp for curing UV ink, and a jam sensor for stopping the carriage when media clogs. Printing occurs as ink is ejected while traversing left and right.

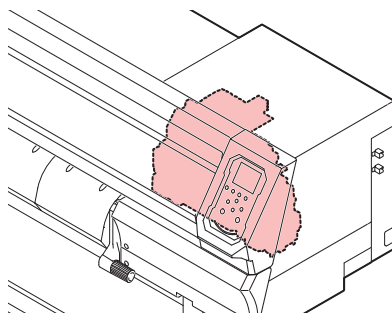

- Use only the UV safety glasses provided. Disregarding this precaution may result in eye pain or damage to eyesight.

Platen

The platen features a large number of holes used to secure the media under vacuum pressure. This also features a cutting slot for cutting the media.

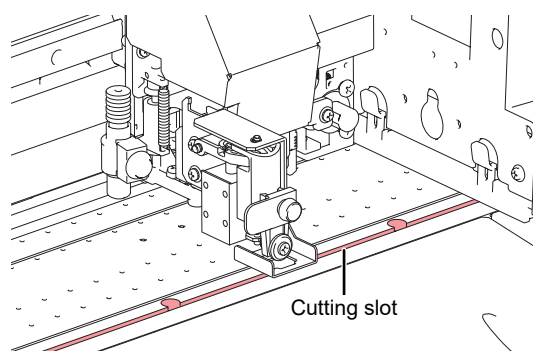

Capping station

The capping station includes caps for keeping the print head nozzle surface from drying out, a wiper required for print head maintenance, and an NCU for monitoring print head nozzle conditions.

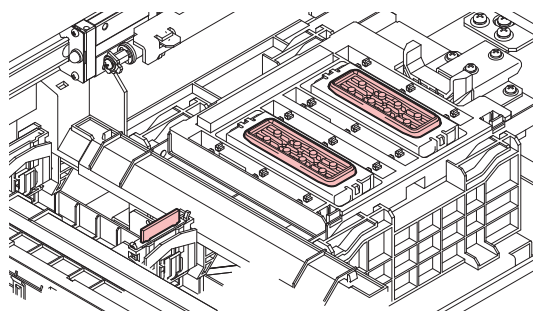

The NCU (Nozzle Check Unit) automatically checks whether the nozzle is clogged. Setting various functions enables automatic print head cleaning or printing using other nozzles.

☞ "Nozzle Check Menu"(P. 122)

☞ "Registering nozzle recovery"(P. 114)

Pinch Rollers and Grid Rollers

The pinch rollers and grid rollers are used to grip and feed the media.

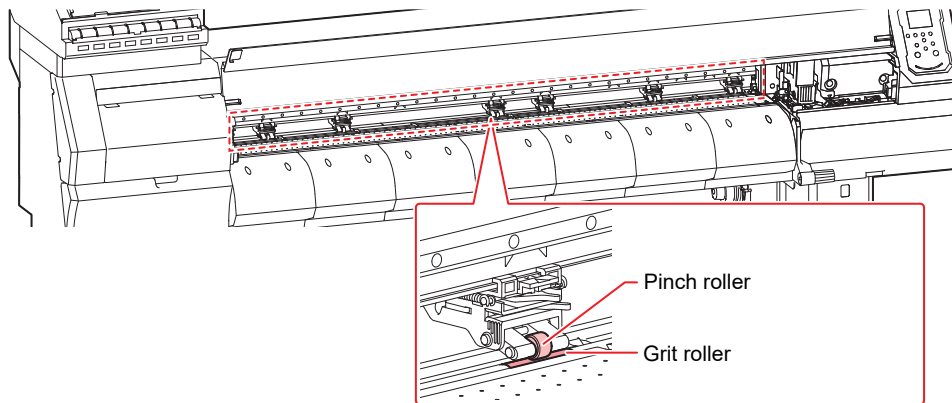

- When this product is not in use, raise the clamp lever to separate the pinch rollers from the grid rollers. If the pinch rollers are left in the lowered position for an extended period of time, they may become deformed, possibly preventing the media from being fed correctly.

Ink status lamp

You can check the status of the ink by looking at the lamp on the ink supply unit.

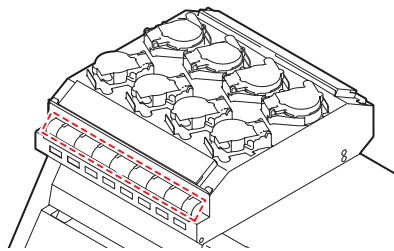

Color	Status	Summary
Blue	Illuminated	Ink is being supplied (no error)
	Off	No error
Yellow	Illuminated Flashing	One of the following errors have occurred: <ul style="list-style-type: none"> • Ink near-end • Ink expired (1 month passed)
Red	Flashing	Ink expired (2 months passed)
	Illuminated	One of the following errors have occurred: <ul style="list-style-type: none"> • Ink end • The ink IC chip is not inserted. • Other ink errors

Media Sensor

The media sensor detects the presence/absence of media.

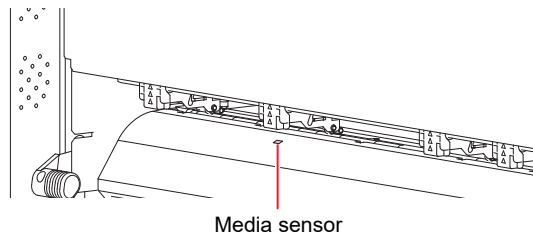

- The sensor must be covered by the media to detect the media width.

Take-up Unit

Use the switch on the take-up unit to change the media take-up direction.

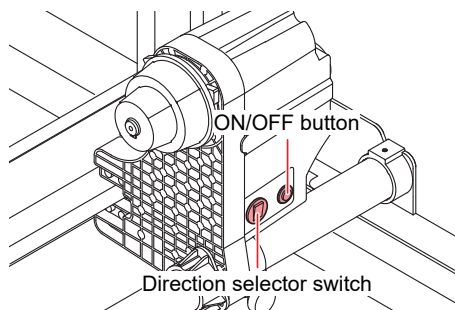

Name	Summary	
Direction selector switch	Up	To take up media with printed surface on the inside
	Down	To take up media with printed surface on the outside
ON/OFF button	Press the button to start/stop the take-up unit. The setting can be altered so that the take-up unit operates only while the button is depressed. ☞ "Machine Setup Menu List"(P. 117)	

Power Supply Switch

This product has the following power supply switches.

● Main power supply switch

This is located on the right-hand side of the product.

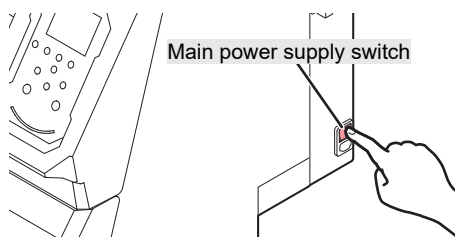



- Do not turn off the main power supply. Turning off the main power supply will disable the automatic maintenance function (including nozzle clogging prevention function and ink discharge channel cleaning function) and may result in printing defects (such as nozzle clogging and deflection) or other faults.

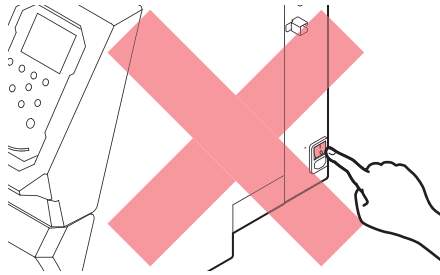

● [END/POWER] key

The [END/POWER] key is the key normally used to turn the power on and off.

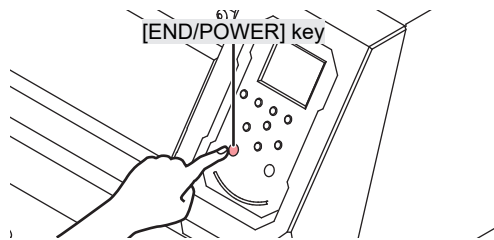

- Close the front cover and maintenance covers. Leaving any of the covers open will disable the automatic maintenance function (including the nozzle clogging prevention function and ink discharge channel cleaning function) and may result in print defects (e.g., nozzle clogging, deflection) or other problems.

Operating panel

This is used to control the product and make/change settings.

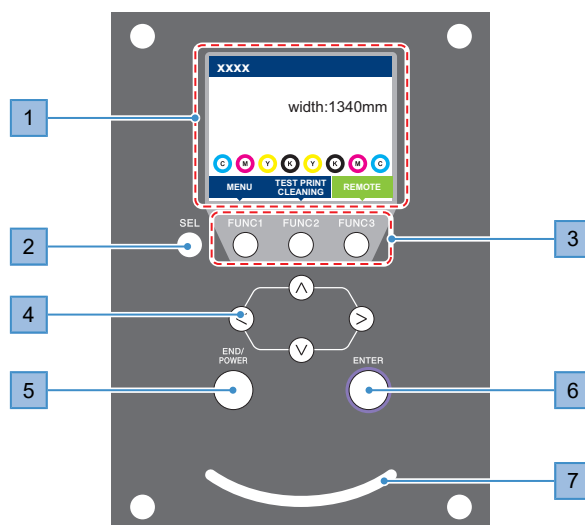

No.	Name	Summary																
1	Display	"Display"(P. 29)																
2	[SEL] key	Selects the function for the corresponding [FUNCTION] key.																
3	[FUNCTION] key	Used for test printing, head cleaning, and editing settings "[FUNCTION] Key"(P. 30)																
4	[JOG] key 	Used to move the carriage, feed media, and select settings																
5	[END/POWER] key	Used to cancel the last setting entered, return to the previous level of the setting menu, or to turn power on and off <ul style="list-style-type: none"> • Illuminates in blue when the power is on. "Turning On the Power"(P. 32) • To turn off the power, hold down the key. "Turning Off the Power"(P. 33) 																
6	[ENTER] key	Used to move to the next level menu and to confirm settings This can also be used to display product information. "Displaying Machine Information (Local Guidance)"(P. 31)																
7	Status lamp	This lamp indicates the product status. <table border="1" data-bbox="454 1406 1436 1924"> <tbody> <tr> <td>Off</td> <td></td> <td>Indicates LOCAL mode. Used for test printing, maintenance, and settings</td> </tr> <tr> <td rowspan="2">Light blue</td> <td>Illuminated</td> <td>Indicates REMOTE mode. The product is in standby to receive print data.</td> </tr> <tr> <td>Flashing</td> <td>Indicates printing is underway. This also flashes to indicate test printing—for example, when printing built-in patterns.</td> </tr> <tr> <td>Blue</td> <td>Illuminated</td> <td>Indicates that data remains to be printed. Switch to REMOTE mode and start printing</td> </tr> <tr> <td rowspan="2">Red</td> <td>Flashing</td> <td>An error has occurred. Refer to the error code list and take appropriate action. Error messages</td> </tr> <tr> <td>Illuminated</td> <td>An error (SYSTEM HALT) has occurred. Contact our service office. SYSTEM HALT</td> </tr> </tbody> </table>	Off		Indicates LOCAL mode. Used for test printing, maintenance, and settings	Light blue	Illuminated	Indicates REMOTE mode. The product is in standby to receive print data.	Flashing	Indicates printing is underway. This also flashes to indicate test printing—for example, when printing built-in patterns.	Blue	Illuminated	Indicates that data remains to be printed. Switch to REMOTE mode and start printing	Red	Flashing	An error has occurred. Refer to the error code list and take appropriate action. Error messages	Illuminated	An error (SYSTEM HALT) has occurred. Contact our service office. SYSTEM HALT
Off		Indicates LOCAL mode. Used for test printing, maintenance, and settings																
Light blue	Illuminated	Indicates REMOTE mode. The product is in standby to receive print data.																
	Flashing	Indicates printing is underway. This also flashes to indicate test printing—for example, when printing built-in patterns.																
Blue	Illuminated	Indicates that data remains to be printed. Switch to REMOTE mode and start printing																
Red	Flashing	An error has occurred. Refer to the error code list and take appropriate action. Error messages																
	Illuminated	An error (SYSTEM HALT) has occurred. Contact our service office. SYSTEM HALT																

Display

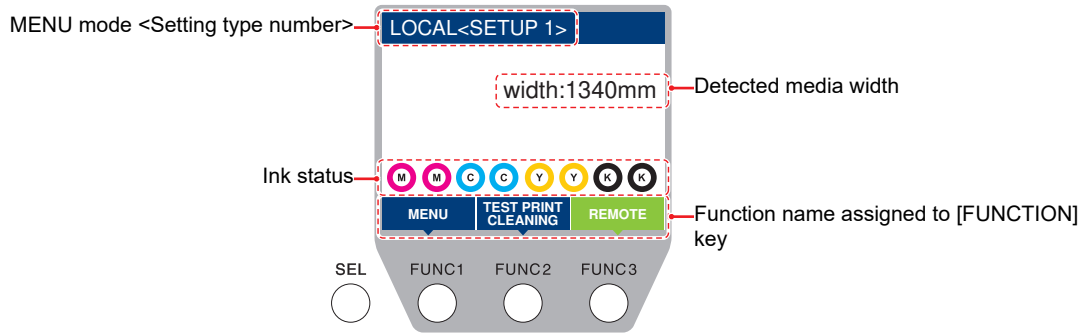

Menu Modes

Four menu modes are available.

Name	Summary
LOCAL mode	Used for test printing, maintenance, and settings
REMOTE mode	Prints the print data received from a PC.
MENU mode	Press the [MENU] in LOCAL mode screen to switch to MENU mode. This is used to set various functions.
NOT-READY mode	Status before cleaning media is detected















Ink Status

Ink bottle status such as remaining ink levels and ink errors are indicated by icons.

Icon	Summary
	Displays remaining ink levels using a 9-stage icon.
	Full 1/8 used 1/4 used 3/8 used 1/2 used 5/8 used 3/4 used 7/8 used Near end
	Displayed when ink is nearly depleted Very little ink remains. Provide fresh ink. * Indicates ink end for UISS (two ink bottles of the same color are fitted).
	Displayed when ink is depleted or an ink error has occurred Printing is not possible. Ink errors (local guidance)
	Displayed when the ink has passed its expiration date. Replace with new ink or use up as quickly as possible. Printing is possible. "Restrictions concerning the product"(P. 13)

[FUNCTION] Key

This section describes the functions and roles assigned to the [FUNCTION] key.

Icon	Summary
	Displays the various menu screens.
	Displays maintenance functions such as test printing and cleaning.
	Used to switch from LOCAL mode to REMOTE mode.
	Displays adjustment functions such as feed adjustment and drop position adjustment.
	Clears received data.
	Used to switch from REMOTE mode to LOCAL mode
	Used to cut media
	Used to move to the previous menu screen
	Used to move to the next menu screen
	Used to close the confirmation screen in response to prompts or other messages
	Used to disable functions
	Indicates that the function is assigned. Displays settings and functions.
	Used to enable or disable multiple items
	Displays the cutting condition input screen.
	Displays the test cutting and other cutting related function screens.
	Displays the pinch roller setting screen.

Displaying Machine Information (Local Guidance)

Press the [ENTER] key in LOCAL mode screen to display the following information.

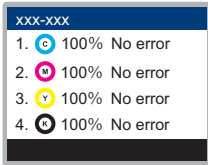
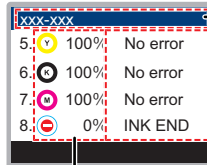
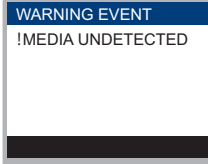
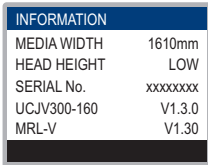
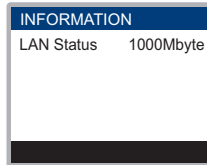
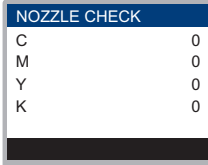
Item	Outline	Display	
Ink information	Displays ink type, remaining ink levels, and ink errors.		 <p>Ink type</p> <p>Ink error</p> <p>Ink level</p>
Warning	Displays all warnings issued.		
Information	Displays information such as media width, head height, product serial number, firmware version, command version, and LAN connection status.		
Nozzle check	Displays the number of nozzles detected to be clogged in the nozzle check.		

1.2 Connecting the Power Cable

- 1** Check to confirm that the main power supply is turned off.
- 2** Insert the cable band to the machine.
- 3** Plug the power cable into the inlet of the machine.
- 4** Secure the power cable to the cable band.
 - Pass the power cable through the clamp and clamp until it clicks into place.

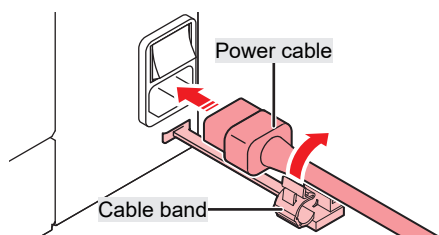

- 5** Plug the power plug into the power outlet.

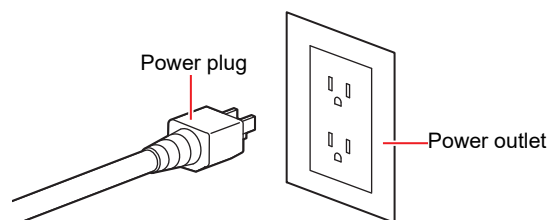

- Do not plug/unplug the power plug with wet hands. Disregarding this precaution may result in electric shock.

Turning On the Power



- Close the front cover and maintenance covers. Leaving any of the covers open will disable the automatic maintenance function (including the nozzle clogging prevention function and ink discharge channel cleaning function) and may result in print defects (e.g., nozzle clogging, deflection) or other problems.

- 1** Check to confirm that the main power supply is turned on.
 - If the main power supply switch is not turned on, set to “I”.
 - Once the main power is turned on, the firmware version will appear on the display, and the initial operation will execute.

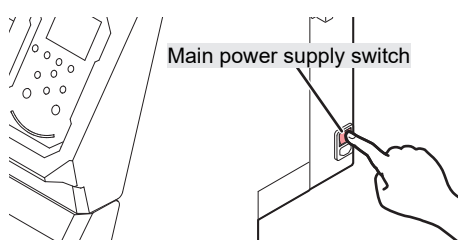

2 Press the [END/POWER] key to turn on power.

- The local mode is set, and the machine is ready for use.

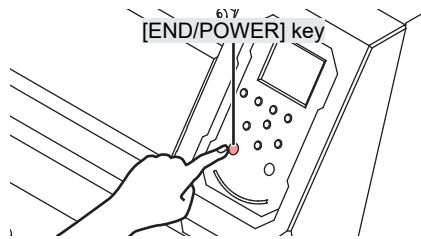
**3 Turn on the power for the connected PC.**

Turning Off the Power

1



- Check the following when turning off power:
 - (1) The front cover and maintenance covers are closed. If any covers are open, the automatic maintenance function is disabled; this may cause the product to fail.
 - (2) The carriage has returned to the capping station. If not, the print head nozzle may dry out, resulting in printing defects (e.g., nozzle clogging, deflection).
 - (3) No print data or cutting data remains.
 - (4) No errors have occurred. ["Problems indicated by messages"\(P. 172\)](#)

1 Turn off the power to the PC connected.**2 Hold down the [END/POWER] key.**

- A power off confirmation screen appears. Press the [ENTER] key to turn the power off.

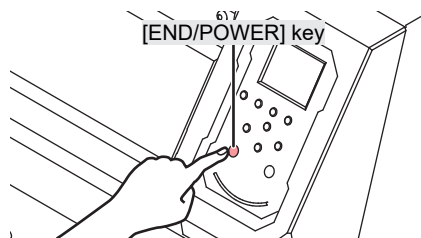

- Do not turn off the main power supply. Turning off the main power supply will disable the automatic maintenance function (including nozzle clogging prevention function and ink discharge channel cleaning function) and may result in printing defects (such as nozzle clogging and deflection) or other faults.

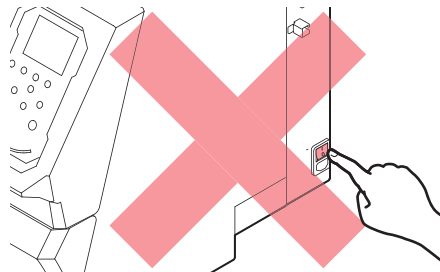

1.3 Connecting a PC to the Product

Using a USB 2.0 Interface Cable

Connect a PC to this product using a USB 2.0 interface cable.



- Do not unplug the cable while data is being transferred.



- Use RIP software that supports the USB 2.0 interface.



- If your PC does not have a USB 2.0 port, contact your local dealer or our service office.

USB 2.0 Interface Precautions

● When connecting more than one UCJV300 Series, 150 Series to a PC

The UCJV300 Series, 150 Series may not be correctly recognized.

If the PC has more than one USB port, try connecting to a different USB port to check whether the product is correctly recognized. If the product is still unrecognized even when connected to a different USB port, use a commercially-available USB 2.0 active repeater cable.

● USB high-speed mode peripheral devices

It may not be possible to recognize USB peripheral devices if USB high-speed mode peripheral devices (e.g., USB memory, USB HDD devices) are connected to the PC to which the product is connected. Data transfer speeds to this product may be reduced if external USB hard disk drives or similar devices are connected. This may cause the carriage to temporarily stop at the left-hand or right-hand end during printing.

● Unplugging USB memory devices

When unplugging USB memory devices from the PC to which this product is connected, use “Stop” in “Safely removing hardware” before unplugging. Otherwise, an [ERROR 10 command error] will occur.

Using a LAN Cable



Connect a PC to this product using a LAN cable. Insert a LAN cable until it engages with a click.



- Do not unplug the cable while data is being transferred.

● Checking the LAN connection

1 Check the display on this product.

- Local guidance can be used for checking.
 "Displaying Machine Information (Local Guidance)"(P. 31)
- Printing is not possible if "100Mbps", "10Mbps", or "No Connect" is displayed. Event email can be used.
 "Event Email Function Settings"(P. 120)

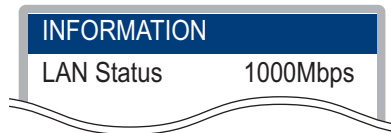

2 Check the lamp on the LAN connector.

- The LAN connector lamp illuminates when this machine is running.

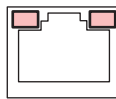

Color	Status	Summary
Green	Illuminated	Connected via 1000BASE-T
	Off	Connected via a network other than 1000BASE-T <ul style="list-style-type: none"> • 1,000 Mbps is not supported if only the orange lamp is illuminated or flashing. Check the specifications for the PC, peripheral devices, and cable.
Orange	Illuminated	Linked up (connected).
	Flashing	Data being received
	Off	Link down (not connected)

Network Connection Precautions

Make sure the network is set up as follows: Printing is not possible if the network is not set up correctly.

- Use a Category 6 or higher LAN cable.
- Use a 1000BASE-T compatible computer or switching hub. Printing requires 1000BASE-T support.
- The PC used to transfer print data must be located on the same network as this product. This product cannot be connected via a router.

● Direct connection to the product



● Connection via a switching hub

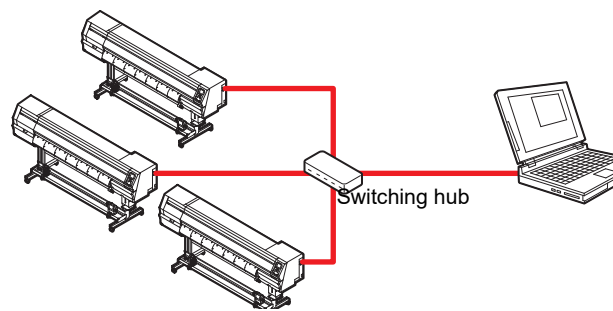

1.4 System Configuration

Use RIP software to request to print data created using applications like Illustrator or Photoshop.

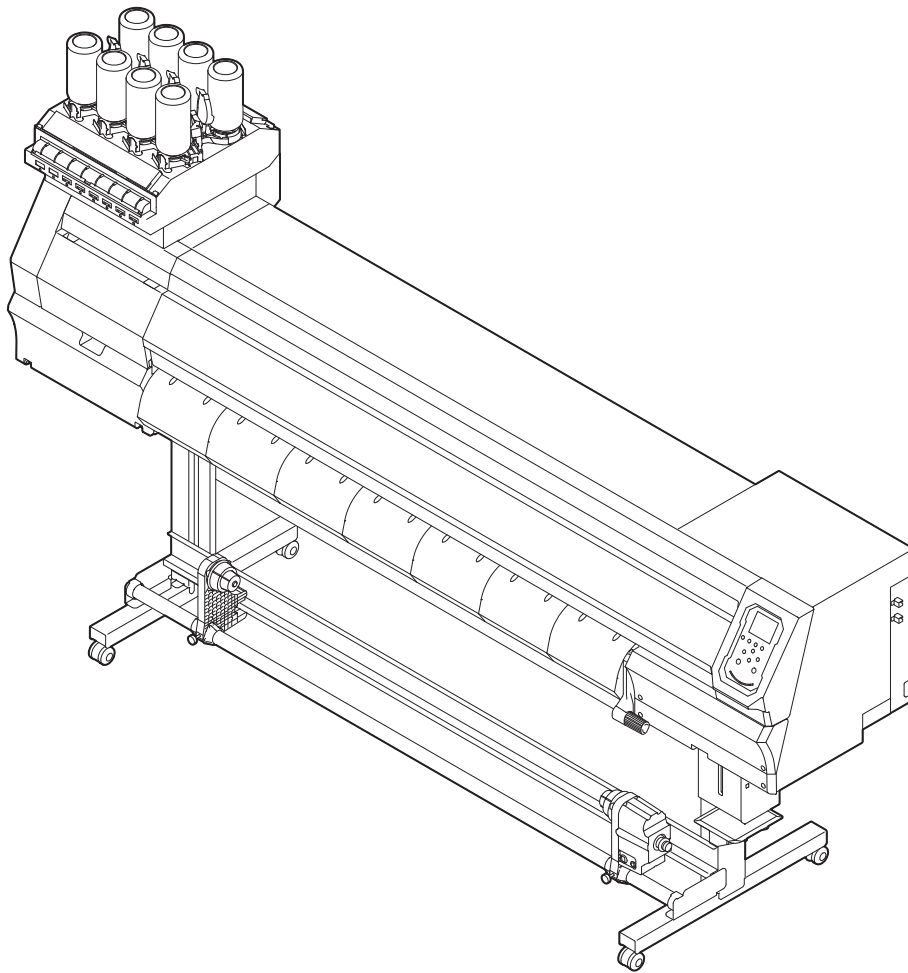
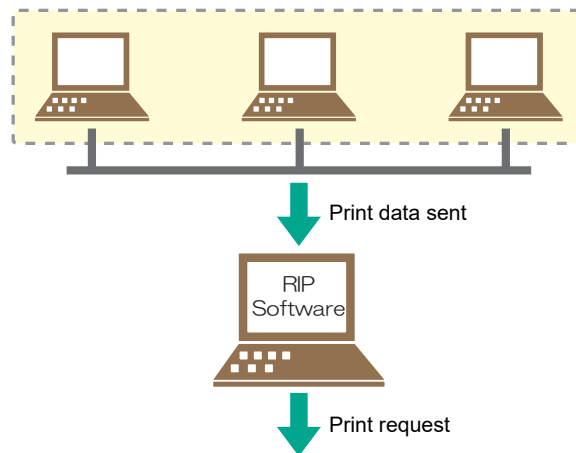

Driver Setup (When Using USB Cable)

1 Install the USB driver.

- Execute [mkcdmenu.exe] contained on the Driver software CD provided.
- The driver can also be downloaded from the following URL:
<https://mimaki.com/download/inkjet.html>
[UCJV300 Series, 150 Series] > [Drivers/Utilities]



- The driver installation guide is provided within the installer.

Installing RIP Software

The explanation here applies to MIMAKI RIP software (RasterLink).

1 Install RasterLink.

- The following icon will appear on the PC desktop once the software is installed.



- For more information, refer to the RasterLink installation guide.
<https://mimaki.com/download/software.html>



- Once this is installed, activate the license for . Otherwise, “Profile Update” will not start.

Obtaining Color Profiles

Print quality (e.g., tone, bleeding) will vary depending on the media and ink set. To maintain consistent print quality, select a color profile that suits the media and ink set.

The explanation here applies to MIMAKI RIP software (RasterLink).

1 Launch “Profile Update”.

- (1) From the Start menu, select [Mimaki RasterLink6Plus] > [Profile Update].
- (2) Click [Next].

2 Select the UCJV300 Series, 150 Series being used.

- Select the check box for the ink set and ink type being used, then click [Next].

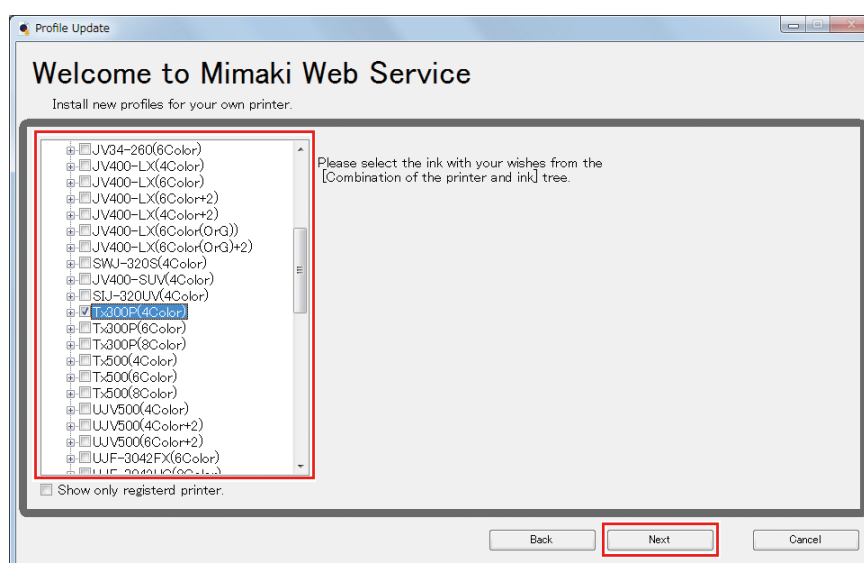

- Expanding the [+] button allows selection of the ink type.

3 Enter the search parameters.

- Enter the search parameters, then click [Next].
- The system looks for the corresponding profile.

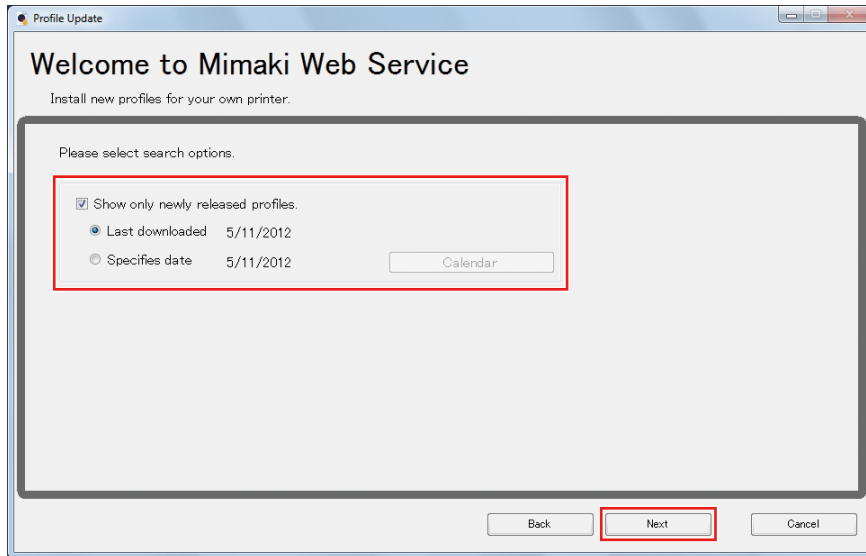

4 Download the color profile.

- (1) Select the check box for the color profile corresponding to the media and resolution to be used.

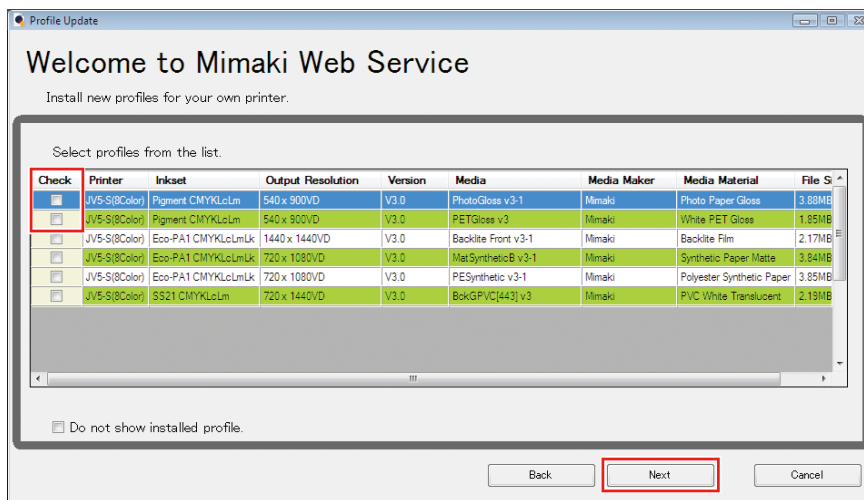

- (2) Click [Next].

- The profile downloaded here will be installed the next time RasterLink is launched.

5 Click [End].

- "Profile Update" closes.



- For more information, refer to the RasterLink installation guide.
<https://mimaki.com/download/software.html>



- The latest color profiles can also be downloaded from the following URL: The profiles downloaded can be installed using Profile Manager.
<https://mimaki.com/download/inkjet.html>

Setting Up RIP Software

The explanation here applies to MIMAKI RIP software (RasterLink).

1 Launch RasterLink.

- The [Printer Management] screen appears.
- To add a new model, launch RasterLink, then select [Environment] > [Printer Management].

2 Register UCJV300 Series, 150 Series.

(1) Click [Add].

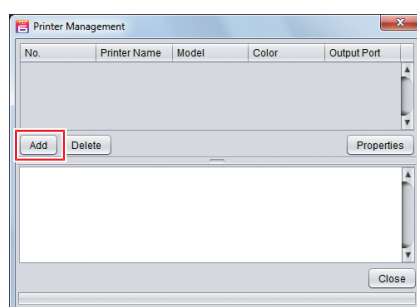

(2) Set the specifics for UCJV300 Series, 150 Series.

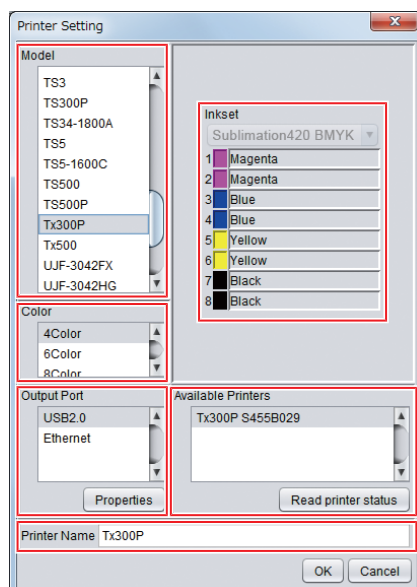

- Model: Select the model.
 - Color: Select the ink set filled.
 - Output port: Select the cable connected.
 - Available Printers: Select UCJV300 Series, 150 Series connected.
 - Printer name: Enter a name as required.
- (3) Click [OK].
- A confirmation screen appears.
- (4) Click [Yes].
- Printer registration starts.



- For more information, refer to the RasterLink reference guide.
<https://mimaki.com/download/software.html>

1.5 Ink Replacement Method

When Ink Near End is Displayed

Ink levels are low. We recommend replacing with new Ink bottle as soon as possible. Although printing is possible, ink may run out during printing.

To check which Ink bottle needs to be replaced, press the [ENTER] key in LOCAL mode screen.

 ["Displaying Machine Information \(Local Guidance\)"\(P. 31\)](#)

When Ink End is Displayed

The ink has run out. Replace with new Ink bottle.

Thoroughly read the following and make sure you understand its contents.

 ["Ink or any Other Liquid Used with the Machine"\(P. 12\)](#)



- Wear safety glasses, gloves, and a mask when handling ink, maintenance cleaning solution, waste ink, or other solutions used with this machine. Leaking ink may adhere to the skin or get into your eyes or mouth.



● Removing the Ink bottle

- 1 Rotate the lever on the tank section from left to right.

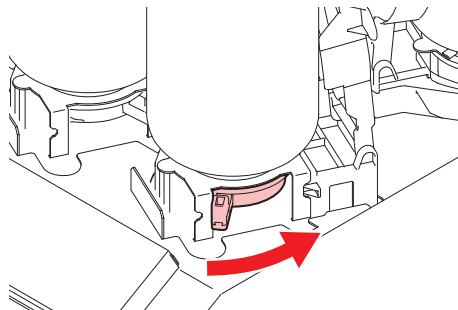

- Never attempt to rotate the ink bottles. Doing so may result in leaking ink.

- 2 Lift the Ink bottle vertically.

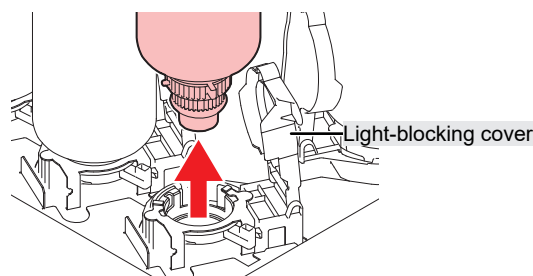



- Check to confirm that the light-blocking cover is closed when removing ink bottles. Close the light-blocking cover by hand if it is not closed. If the light-blocking cover is left open, the ink may harden, resulting in printer failure.
- Be careful to prevent ink leaks from the bottles.

3 Soak up any ink droplets on the special caps.

- Use a wipe filter to soak up ink droplets and prevent dripping.

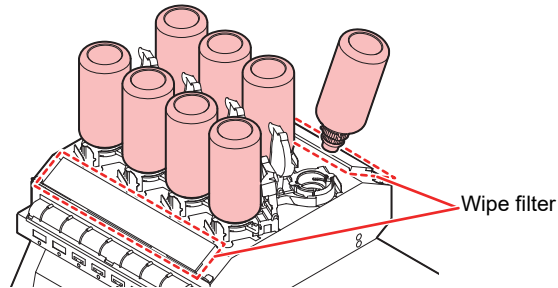

4 Wipe off any ink on the special caps with paper wipes.



5 Remove the special caps from the Ink bottle.

- If the special caps are tight, remove using a tightening tool.

6 Remove the ink IC chip.

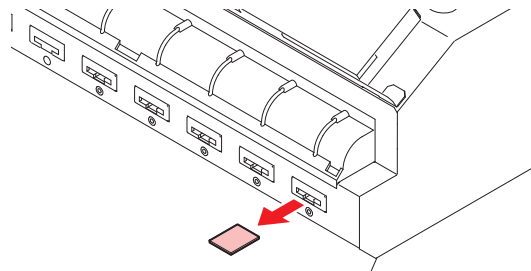

- When disposing of the product, contact an industrial waste disposal operator or dispose of the product in accordance with the local laws and regulations.

● **Preparing New Ink Bottles**

1 Pull out the ink pack and the ink IC chip from the ink package.

● Shaking the Ink bottle

1 Shake the Ink bottle to the left and right slowly at least 20 times.

- Tighten the ink bottle lid securely, then shake the bottle slowly from left to right to ensure that the ink moves inside, holding the ink bottle lid with a paper towel.

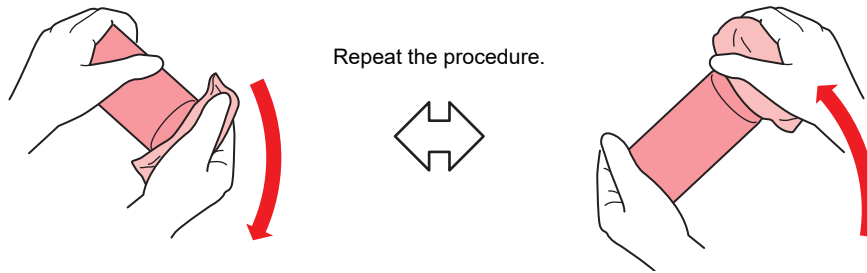

- Shake slowly. If the bottle is shaken too violently, ink may leak out or the air mixed in the ink may cause nozzle clogging.
- If the Ink bottle is partially used, flip the Ink bottle upright and shake slowly at an angle.

● Preparing Ink Bottles

1 Remove the ink bottle lid.

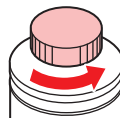

- If the mouth of the ink bottle is fitted with a seal, cut this open using a craft knife. Be careful not to drop the cut seal into the bottle.

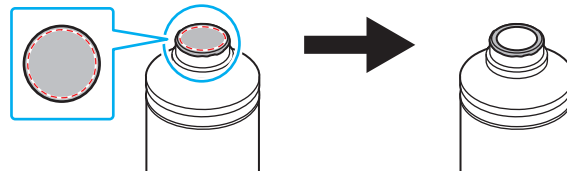

2 Place the special cap on the ink bottle.

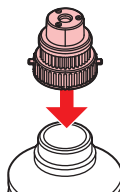

- Wipe off any ink or washing liquid if it remains on the ink bottle or special cap. Failure to do so may result in idling of the special cap and ink leakage.

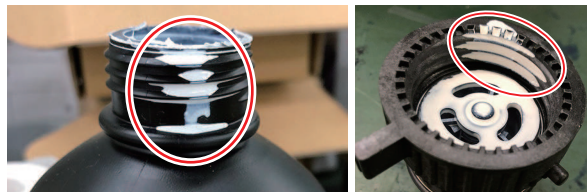

3 Use the tightening tool to tighten the special cap in place.

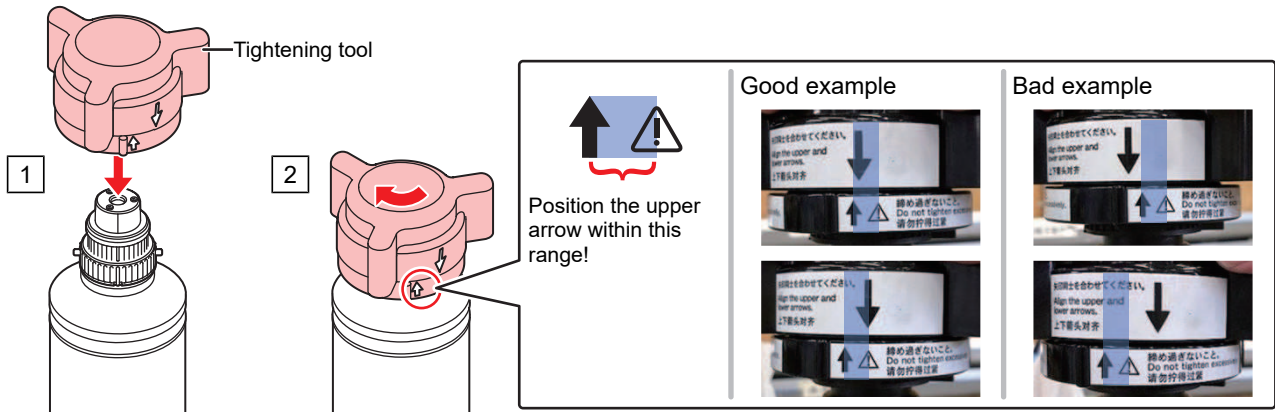

- Do not overtighten the special cap. Disregarding this precaution may result in damage, idling or ink leakage. If the arrow moves beyond the above range, loosen the special cap, and repeat the steps again.
- Do not leave ink bottles with special caps fitted for extended periods. Doing so may result in ink hardening.

4 Turn the ink bottle upside-down to check that no ink leaks occur.

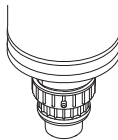

● Mounting Ink Bottles

The order of Ink bottle to be set depends on the ink set you are currently using. Check the ink slot numbers, then insert the correct color Ink bottle.

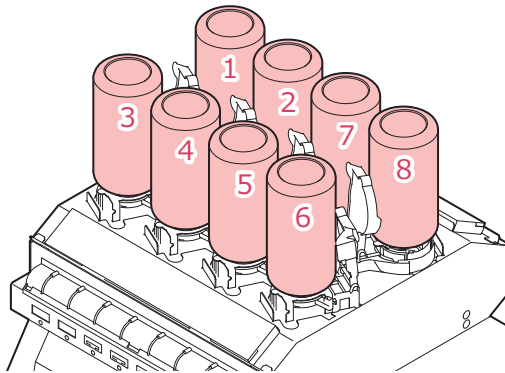

Model	Ink set	Ink layout							
		1	2	3	4	5	6	7	8
300 series	4-color	C	M	Y	K	Y	K	M	C
	4-color, W	C	C	M	M	Y	K	W	W
	4-color, W, CL	C	M	Y	K	CL	CL	W	W
	6-color, W	C	M	Y	K	Lm	Lc	W	W
150 series	4-color	-	-	C	M	Y	K	-	-

1 Mount ink bottles in the tank.

- Rotate the lever on the tank section from the left to the right end, then mount the ink bottle.

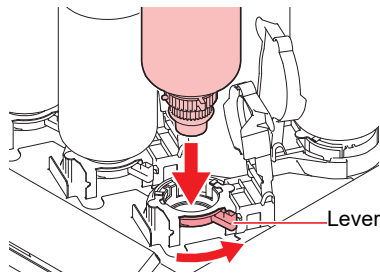

2 Turn the tank lever from right to left to secure the bottle.



- Never attempt to rotate the ink bottles. Doing so may result in leaking ink.



- Once the ink bottle is mounted, use up the ink as quickly as possible.

● Insert Ink IC Chip



- Do not touch the metal parts of the ink IC chip. Dirt or damage may prevent data transfers or result in damage to the ink IC chip due to static electricity.



- Insert the ink IC chip with the metal side facing up. Inserting it in the wrong way may cause failure or damage to the ink IC chip.

1 Insert a new ink IC chip into the slot on the ink supply unit.

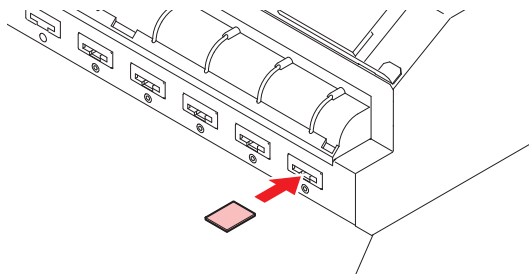

● Ink IC Chips

Each ink IC chip has a marking indicating color information.

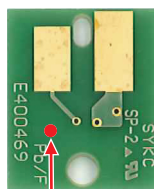

Marking location

Ink color	Marking
Cyan	● (One blue circle)
Magenta	● (One red circle)
Yellow	● (One yellow circle)

Ink color	Marking
Black	● (One black circle)
Light cyan	●● (Two blue circles)
Light magenta	●● (Two red circles)
White	○ (One white circle)
Clear	○○ (Two white circles)



- Insert the ink IC chip contained in the ink package. The ink IC chip stores information such as the ink color, remaining amount, and expiration date. Printing is not possible if a wrong IC chip is inserted.

Chapter 2 Printing



This chapter

This chapter describes printing procedures and setting methods.

Print Process	48	Test Printing	67
Adjusting Print Head Height	51	Changing the Layout Direction for Test Printing	67
Adjusting the Pinch Roller Positions.....	52	Checking White Ink Ejection	67
1,600 mm size	53	Printing Defects.....	68
1,300 mm size	54	Head Cleaning.....	69
1,070 mm size	55	Feed Correction.....	70
750 mm size	56	Feed Correction Procedure.....	70
Loading the Media	57	Correcting the Drop Position	72
Media	57	Drop Position Correction Procedure	72
Loading the Roll Media	57	Printing RIP Data.....	73
Setting Leaf Media	62	Preparing RIP Data	73
Setting the Pressure and Number of Pinch Rollers to Use	66	Changing the Origin	75
		Starting Printing	75
		Stopping Printing (Data Clear)	76
		Cut the media.	77

2.1 Print Process

1. Turn on the power.

 ["Turning On the Power"\(P. 32\)](#)

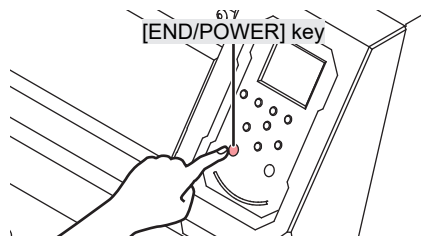

2. Connect a RIP PC to the machine.

 ["Using a USB 2.0 Interface Cable"\(P. 34\)](#)

 ["Using a LAN Cable"\(P. 34\)](#)

3. Setting Up RIP Software

 ["Installing RIP Software"\(P. 38\)](#) (required first time only)

 ["Obtaining Color Profiles"\(P. 38\)](#)

 ["Setting Up RIP Software"\(P. 40\)](#) (required first time only)

4. Adjust print head height.

Adjust the height adjustment lever to suit the medium.  ["Adjusting Print Head Height"\(P. 51\)](#)

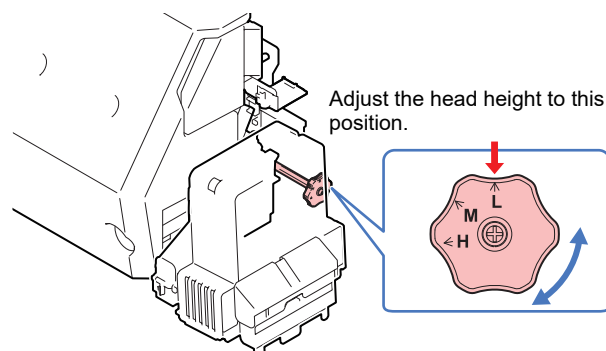

5. Adjust the pinch roller positions.

Adjust the pinch roller positions to suit the width of the set media. Adjust the pinch roller positions so that the pinch rollers are positioned above the grit rollers. The pinch rollers at both ends should be aligned to within 10 cm from the left edges and 2 cm from the right edges of the media.  ["Adjusting the Pinch Roller Positions"\(P. 52\)](#)

6. Load the media.

This machine can be used with roll media and leaf media.  ["Loading the Media"\(P. 57\)](#)

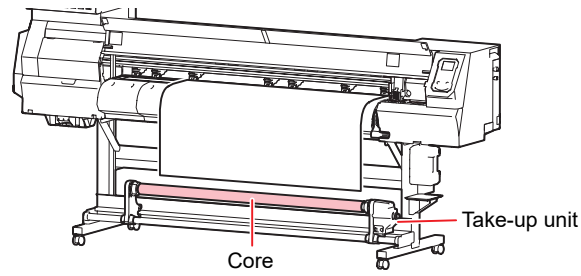

7. Adjust the number and pressure of pinch rollers to use.

Set an appropriate pressure for the set media.  ["Setting the Pressure and Number of Pinch Rollers to Use"\(P. 66\)](#)

8. Check the state of the print head nozzles.

 ["Test Printing"\(P. 67\)](#)

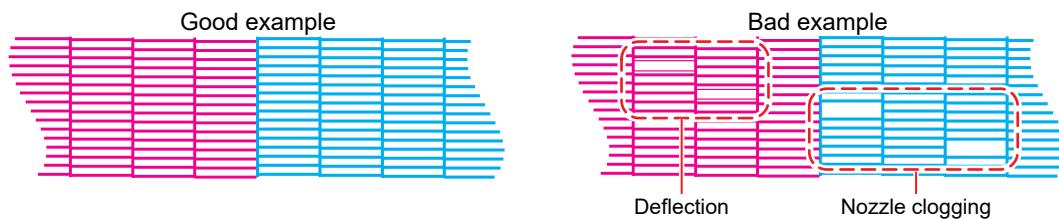

9. Clean the head to clear malfunctioning nozzles.

There are four different head cleaning methods. Choose the head cleaning method based on test print results.  ["Head Cleaning"\(P. 69\)](#)

10. Adjust the media feed amount.

 ["Feed Correction"\(P. 70\)](#)

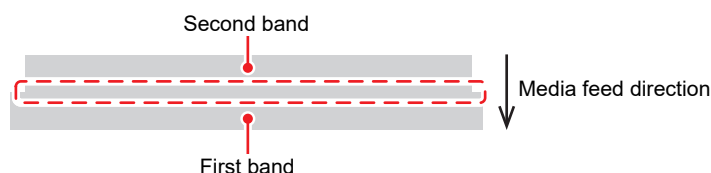

11. Adjust the drop position for bi-directional printing.

☞ "Correcting the Drop Position"(P. 72)

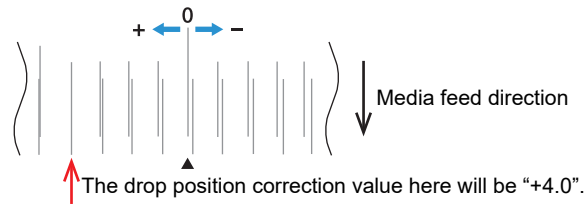

12. Printing RIP Data

☞ "Printing RIP Data"(P. 73)

13. Cut the media.

☞ "Cut the media."(P. 77)

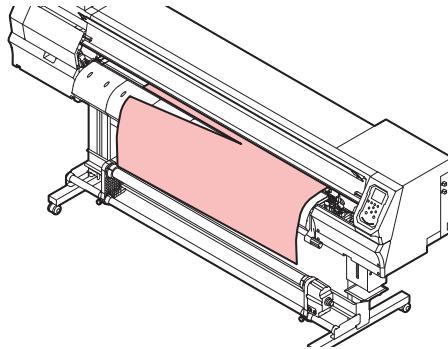

2.2 Adjusting Print Head Height

Adjust the print head height to suit media thickness.

Range	Gap between print head and platen
Low	2 mm (default setting)
Middle	2.5 mm
High	3 mm



- The print head height should normally be set to 2.0 mm. If the gap exceeds 2.5 mm, the ink droplets may vaporize before reaching the media. Vaporized ink will adhere to the print head nozzle surface and cooling fan filter. The amount of reflected light incident on the print head surface from the UV-LED unit will also increase. Reflected light may cure vaporized ink adhering to the nozzle surface. This will increase viscosity, reduce print quality, and generate print head faults.

1 In LOCAL mode screen, select [MENU] > [Maintenance], then press the [ENTER] key.

- The Maintenance menu is displayed.

2 Select [Station] > [Carriage Out] > [Station Maint.], then press the [ENTER] key.

- The carriage moves over the platen.

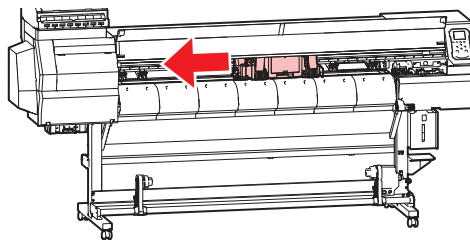

3 Open the front cover.

4 Use the height adjustment lever to adjust the height.

- Set the height adjustment lever so that the desired height is at the top. If the lever is not set to the correct position, problems such as media jamming and misting may occur, resulting in impaired print quality.

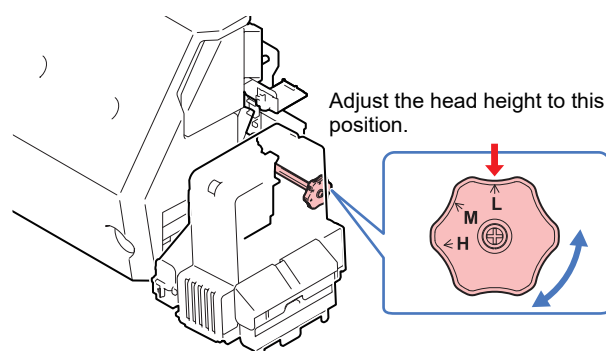

5 Press the [ENTER] key once adjustment is complete.

6 Close the front cover, then press the [ENTER] key.

2.3 Adjusting the Pinch Roller Positions

Adjust the pinch roller positions to suit the width of the media being used.



- Always use at least two pinch rollers.

1 Choose the grid rollers capable of holding down the media at equal intervals.

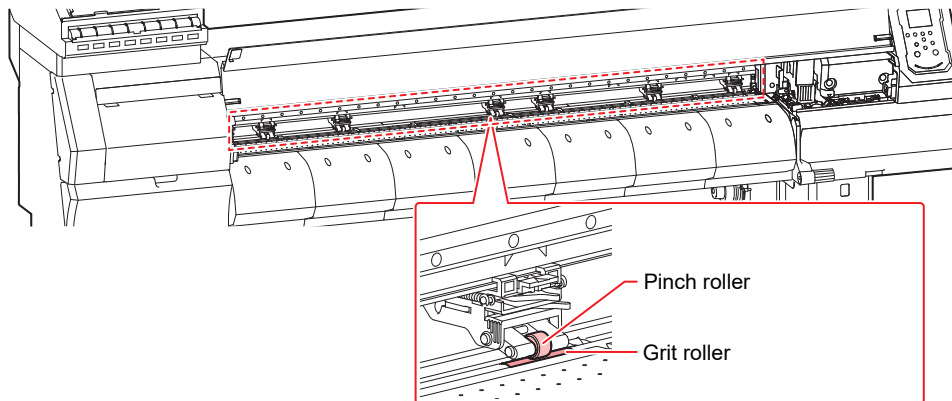

2 Move the pinch rollers above the grit rollers.



- Use the pinch roller guide marks as references.

- When adjusting from the front

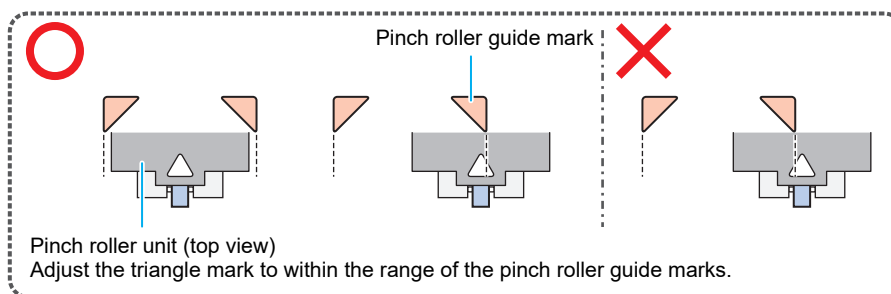

- When adjusting from the rear

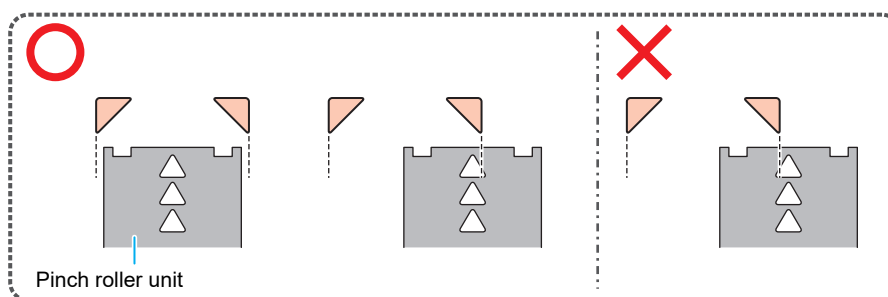

3 Align the pinch rollers at both the ends to within 10 cm from the left edges and 2 cm from the right edges of the media.

- Placement farther from the edges may leave some portions of the media uncut.

4 Remove the pinch rollers lying outside the media from the grit rollers.

- Feeding media with the pinch rollers and grit rollers in contact will cause pinch roller wear.

1,600 mm size

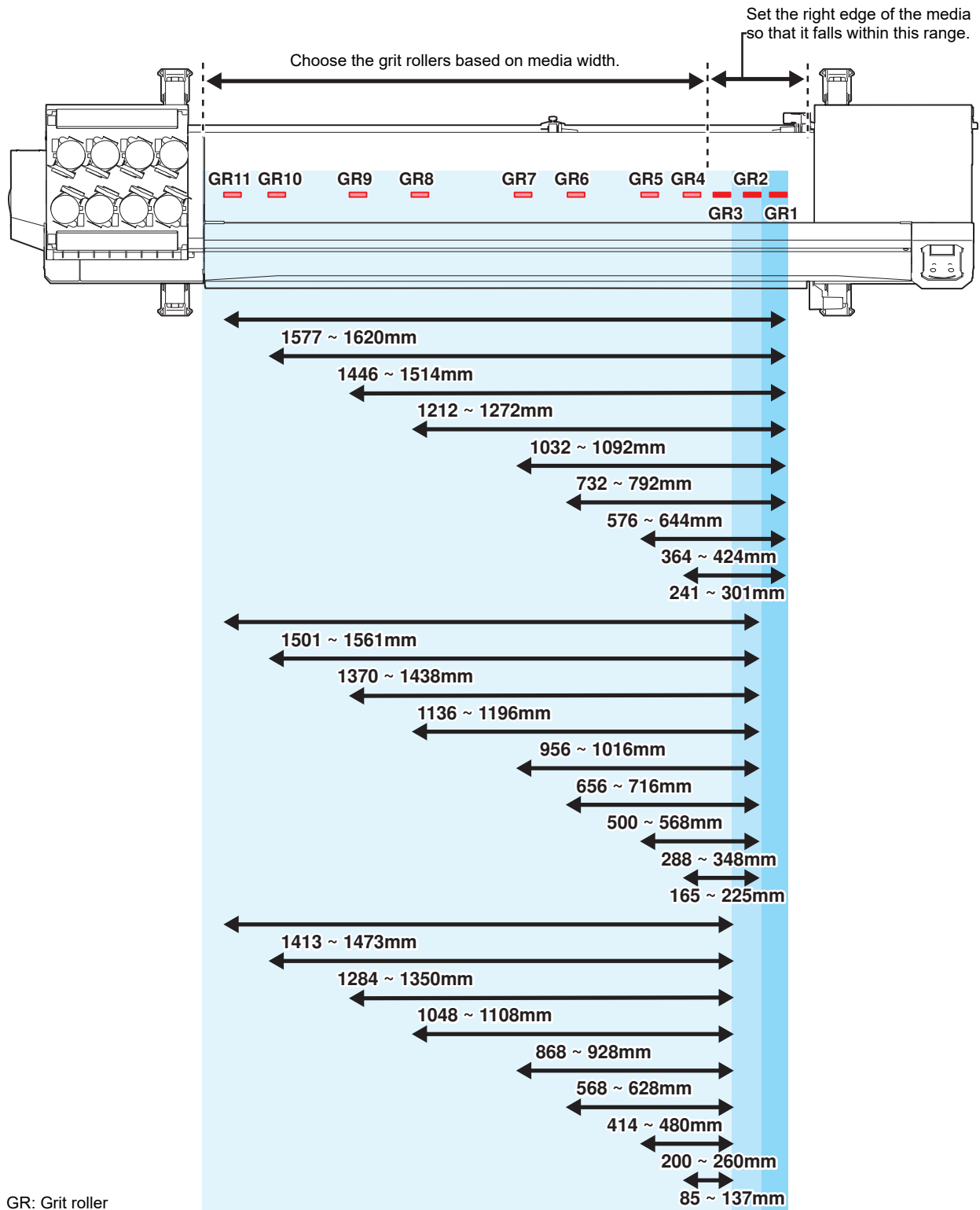

1,300 mm size

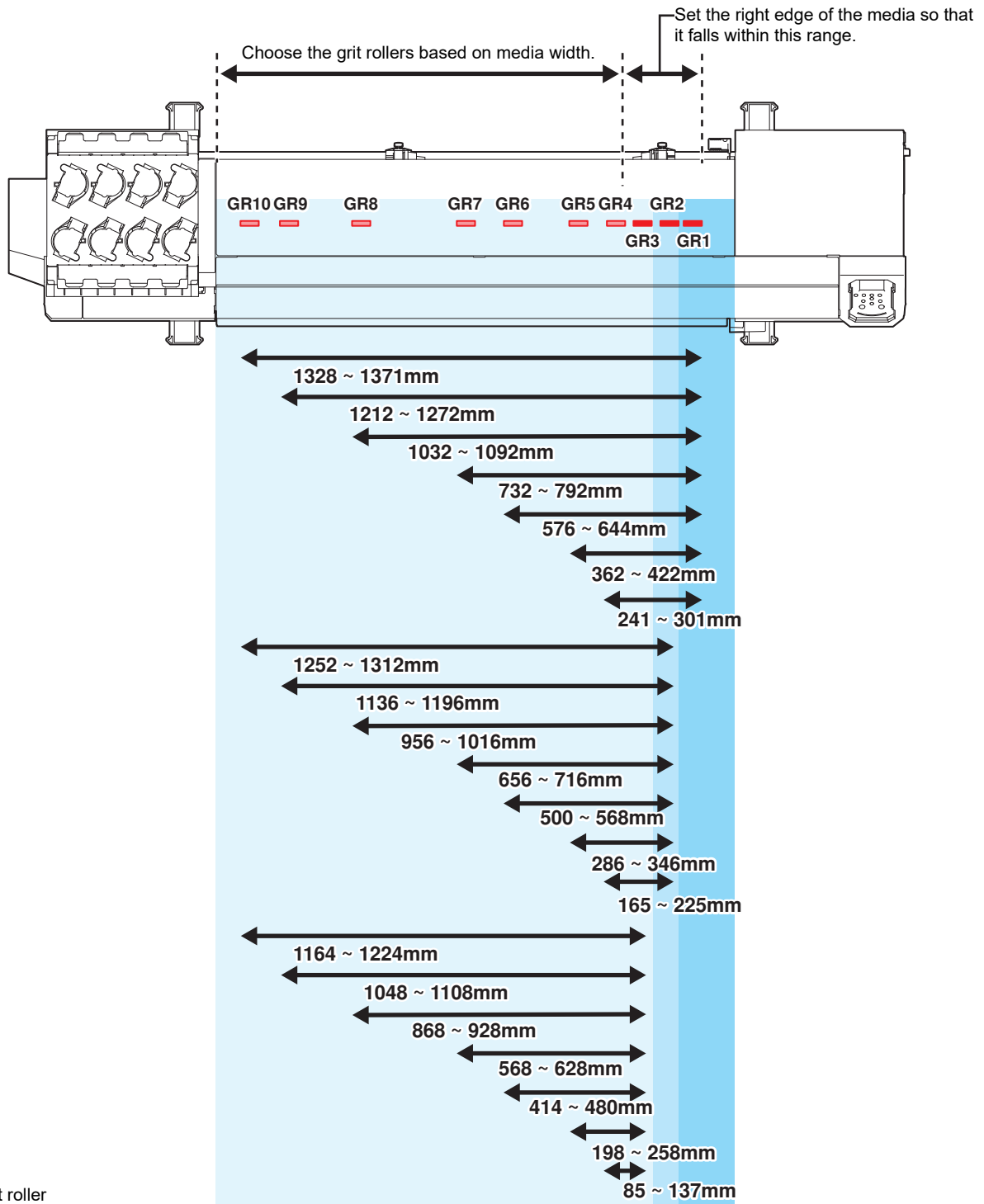

GR: Grit roller

1,070 mm size

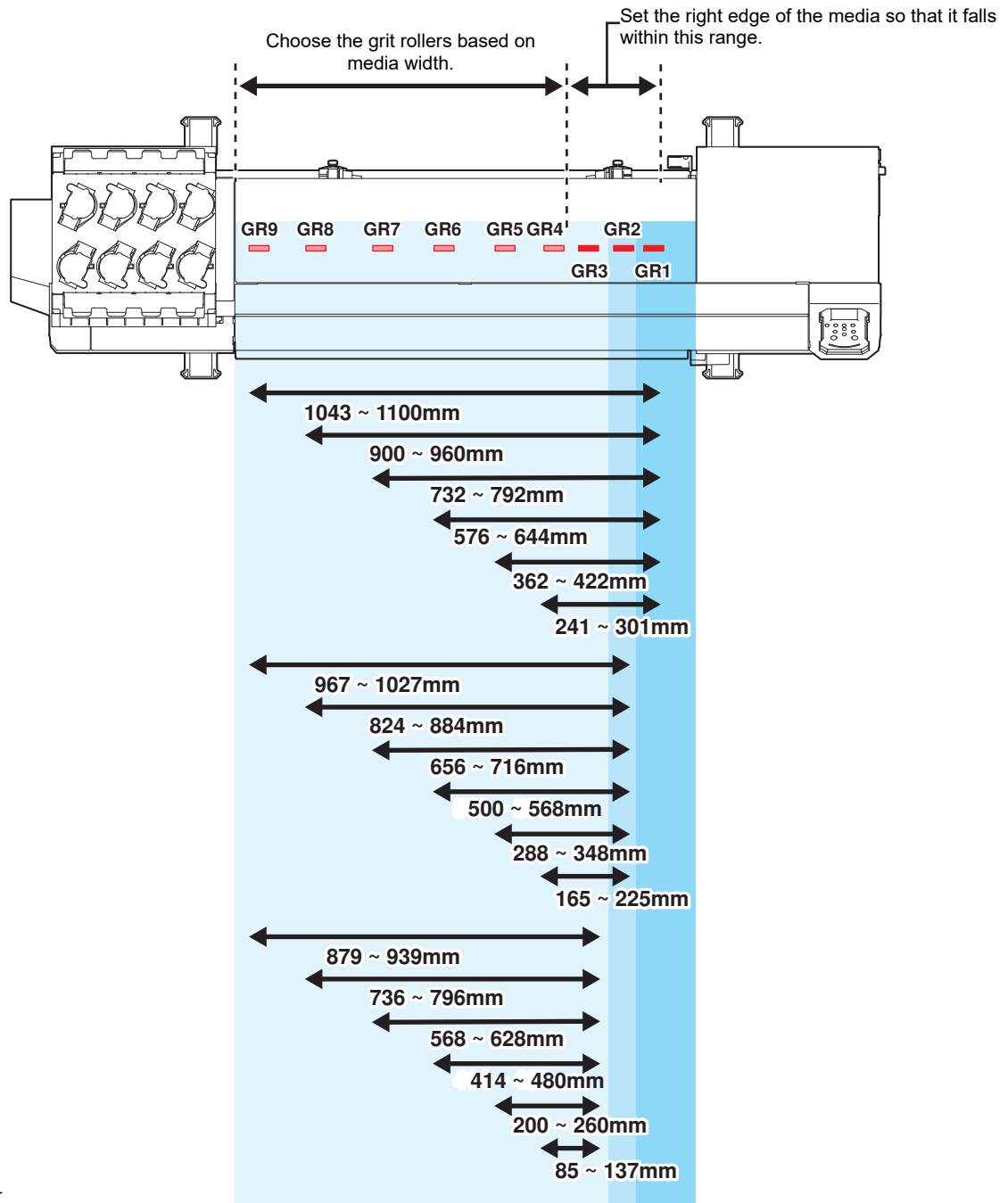

GR: Grit roller

750 mm size

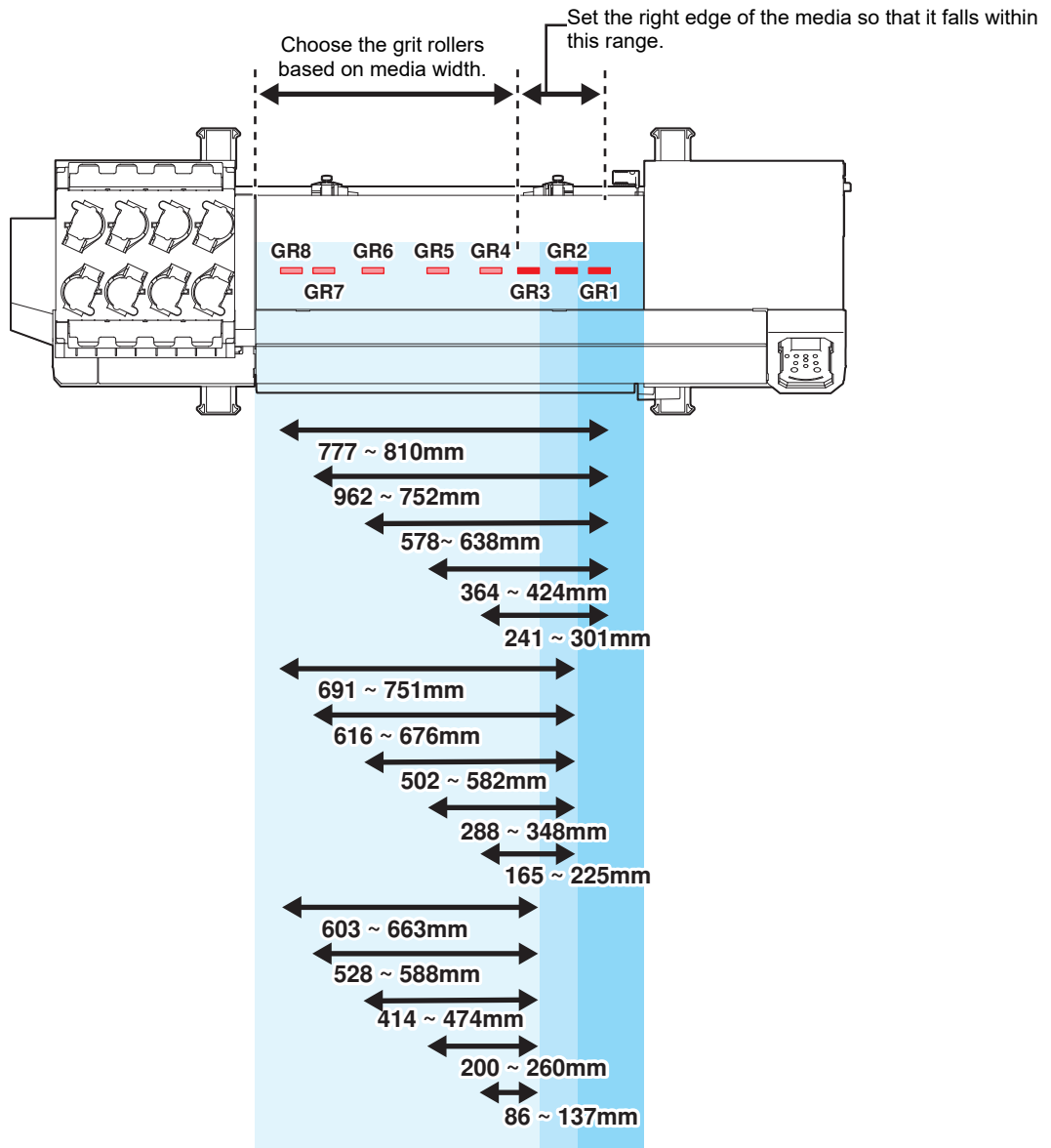

GR: Grit roller

2.4 Loading the Media



- Adjust the head height before loading media. Moving the carriage after the media has been loaded may result in jammed media or damage to the print head.

Media

● Media handling precautions



- Use Mimaki-approved media to ensure consistent high-quality printing.

⚠ WARNING



- Assign at least two people to load roll media. This will reduce the risk of back injury due to the weight of the roll media.

NOTICE



- Protect media from dust when stored. This will help preserve print quality.
- When storing standard-size media rolled up, store with the coated surface facing out.
- Take precautions to prevent static electricity buildup on media. (e.g., ionizers, discharging bars, water mist humidification, or alcohol-based anti-static solutions. *Ionizers can be fitted to models equipped as standard or models for which the option is available. * Do not use anti-static solutions that contain detergent.)



- Do not leave media loaded in the machine. This may cause dust to collect on media.
- Do not use media immediately after removing from the packaging. The media may expand or shrink depending on the ambient temperature and humidity at the storage location. Allow to sit for at least 30 minutes in the same room with the machine before loading.
- Do not use curled media. Doing so may result in jammed media and impaired print quality.
- Do not use media after wiping off dust. The static electricity generated by wiping may impair print quality.
- Do not use mirrors, polished stainless steel plate, or gold or silver foil media. Light reflected from the media surface may result in print head ink hardening and damage to the head. Such damage is not covered by the warranty.

Loading the Roll Media

- 1 Raise the clamp lever.

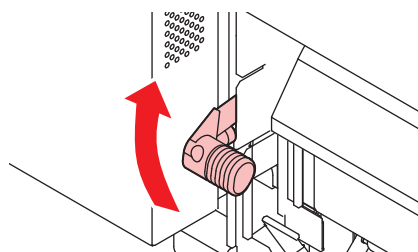

2 Move the rear left roll holder to the roll setting position.

- Unscrew the roll holder retaining screw before moving.

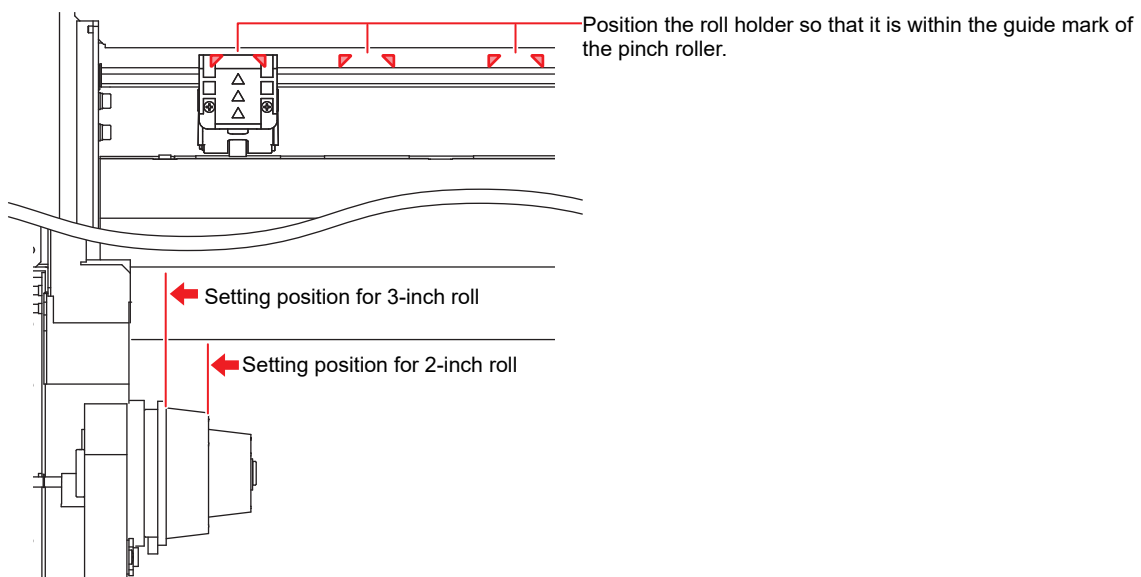

3 Tighten the retaining screw on the rear left roll holder.

4 Place roll media on the roll media hanger.

5 Attach the core of the roll medium to the rear left roll holder.

- Push until the core moves no farther.

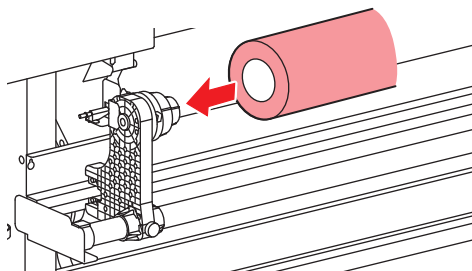

6 Insert the rear right roll holder into the core.

- Unscrew the roll holder retaining screw before moving.

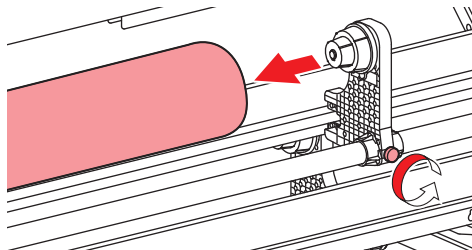

7 Tighten the retaining screw on the rear right roll holder.

8 Insert the medium.

- Insert into the gap between the pinch roller and the grit roller.



- Inserting media at an angle allows smooth insertion without catching or sticking.

9 Lower the clamp lever.

- Hold the media with the pinch roller and grid roller.

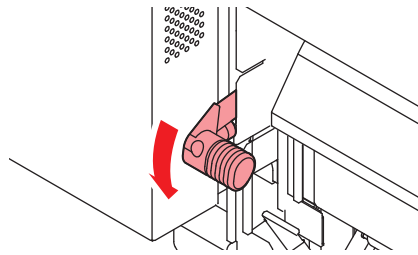

10 Move to the front of the machine and open the front cover.

11 Raise the clamp lever and pull out the medium.

- Make sure the medium does not fall to the rear.



- Adjust the rear roll holder position so that the medium does not cover the right-hand slit line on the platen. Movement at an angle may result in damage to the print head.

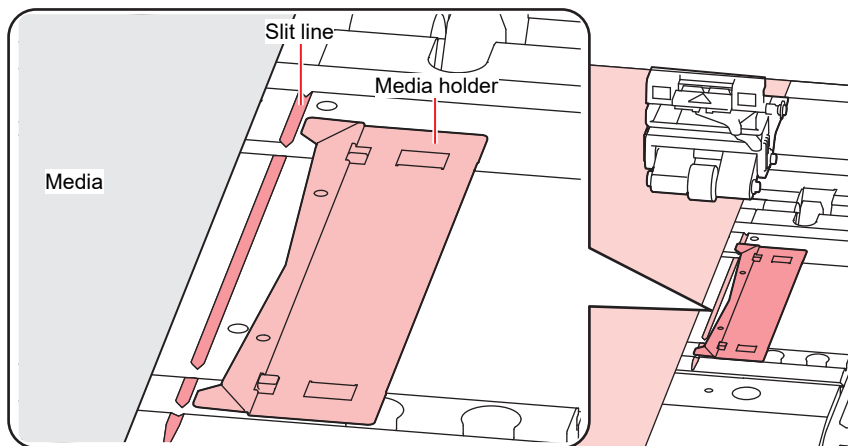

- The areas extending 5 mm from both sides of the media are margins.

12 Lower the clamp lever to confirm that the spacing from the pinch roller is uniform.

-  ["Adjusting the Pinch Roller Positions"\(P. 52\)](#)



- If not, repeat all steps from the start.

13 Raise the clamp lever.

14 Gently pull out the medium and stop at the position where it is gently locked in place.

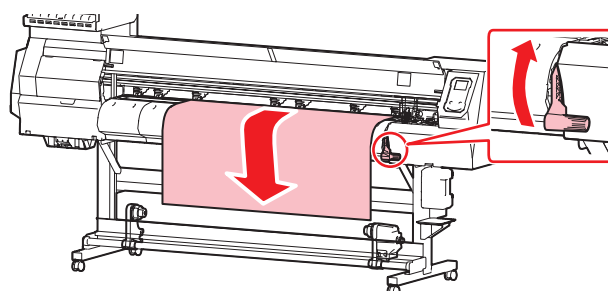

15 Check how far the medium was pulled out.

- Pull the front edge of the medium gently at several points to confirm that the medium was pulled out by the same amount.

16 Lower the clamp lever.

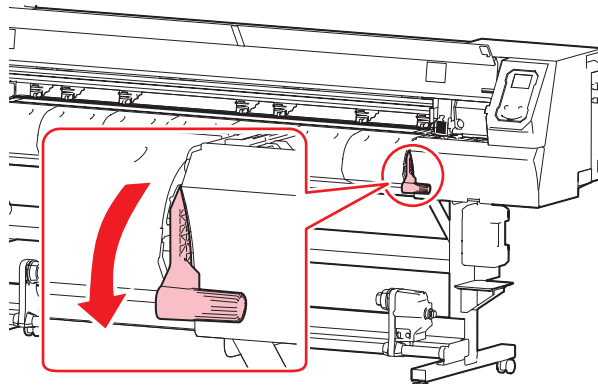

17 Secure the medium in the media holder.

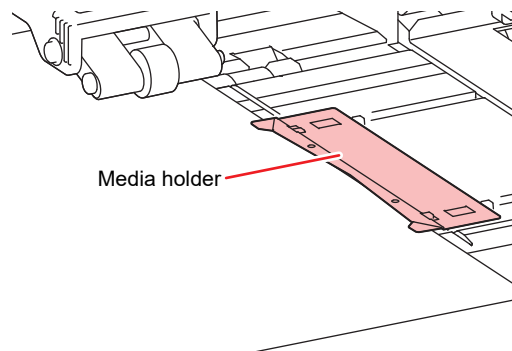

- Do not use the media holder when printing on thicker media.



- Do not use the media holder when cutting media.

18 Press , then select “Roll”.

- This starts media width detection.
- If the setting for [Machine Setup] > [Media Detect] > [Detection Type] is “MANUAL”, the area for printing must be determined manually.
- If the setting for [Machine Setup] > [Media Detect] > [Media Remain] is “ON”, the media length input screen will be displayed.



- A notification reading “Media Set Position R” will appear if the medium is too far to the right of the specified position. Reload the media.

19 Enter the number of pinch rollers being used.

- If the setting for [Machine Setup] > [Media Detect] > [Use PR Number Query] is “OFF”, the screen for entering the number of pinch rollers will be displayed.

20 Load an empty core on the take-up unit.

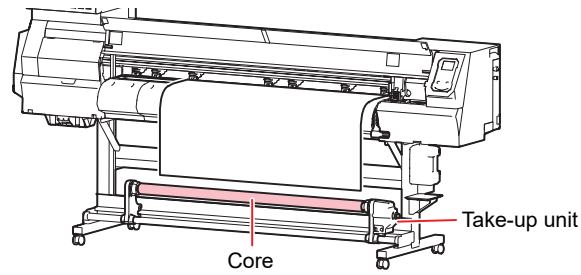

21 Secure the medium to the take-up unit.

- (1) Press ▼ to feed the medium until it reaches the core on the take-up unit.
- (2) Secure the middle of the medium with adhesive tape.
- (3) Secure the medium on the right and left in the same way.
 - Pull the lower edge of the medium evenly on both the left and right sides, check to confirm that it is free of sagging and creasing, then affix the tape.

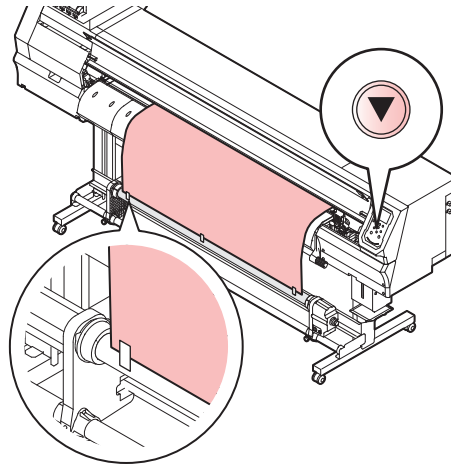

- Move the take-up unit to the left or right if not in use. Print quality may be affected if the front edge of the medium hits the take-up unit during printing.

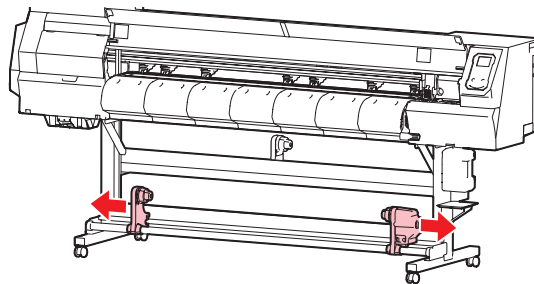

Adjusting the Torque Limiter

The take-up unit is fitted with a torque limiter. Turn the torque limiter adjustment nut to adjust take-up tension. The torque limiter is initially set to “Medium” when shipped.

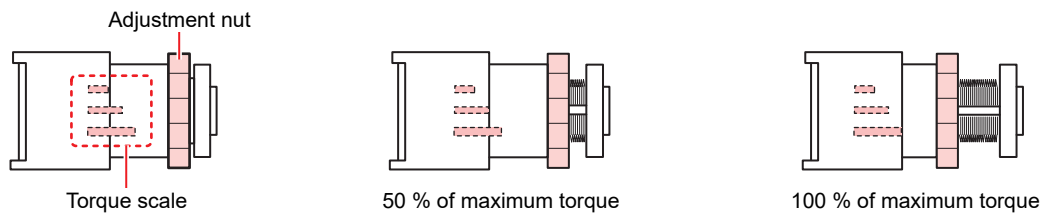

● Increase tension (clockwise)

Increase tension when using with heavy or thick media, such as tarpaulin. Perform adjustments manually.

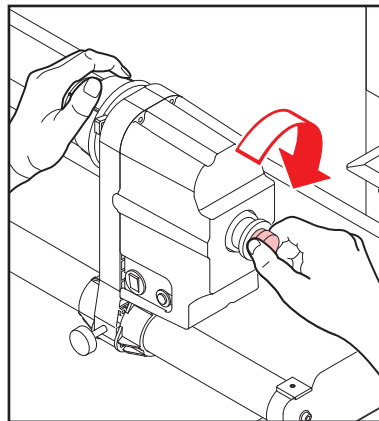

- Do not use the torque adjustment handle. Overtightening with the torque adjustment handle may damage the take-up unit.

● Decrease tension (counterclockwise).

Decrease tension when using lightweight media. Use the “torque adjustment handle” provided.

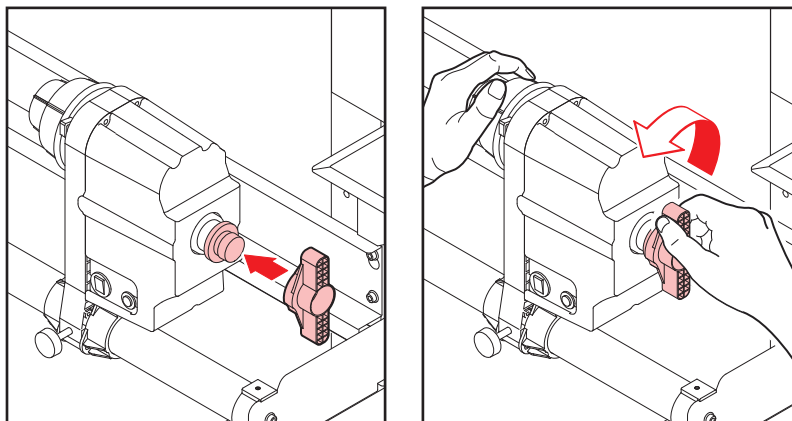

Setting Leaf Media

The roll holder and the roll hanger are not used with leaf media.

1 Move the take-up units to left and right.

- Print quality may be affected if the front edge of the medium hits the take-up unit during printing.

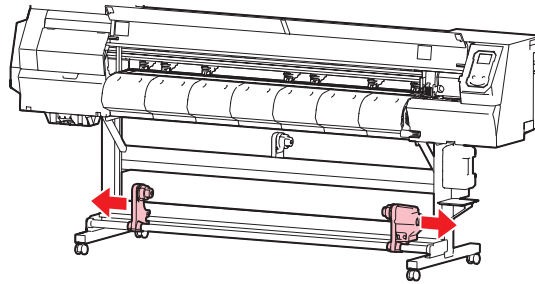

2 Raise the clamp lever.

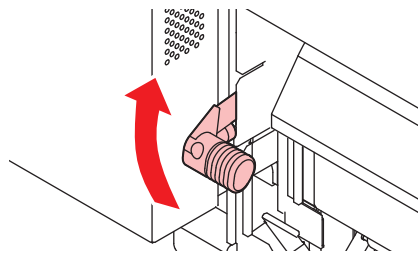

3 Open the front cover.

4 Insert the medium.

- Insert into the gap between the pinch roller and the grit roller.



- Inserting media at an angle allows smooth insertion without catching or sticking.

5 Adjust the position of the right media edge.

- Set the media straight so that the media does not lie beyond the slit line on the platen.

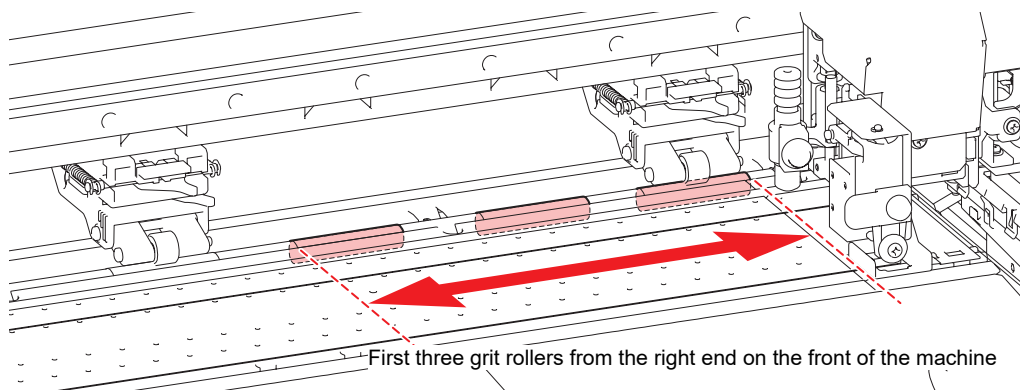

- The areas extending 5 mm from both sides of the media are margins.

6 Adjust the position of the front media edge.

- Set the media so that at least 40 mm of the media lies on the after cover. If not, the media width may not be detected.

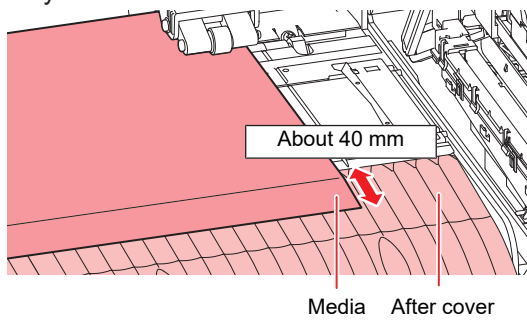

7 Lower the clamp lever to confirm that the spacing from the pinch roller is uniform.

- Hold the media with the pinch roller and grid roller.
-  ["Adjusting the Pinch Roller Positions"\(P. 52\)](#)



- If not, repeat all steps from the start.

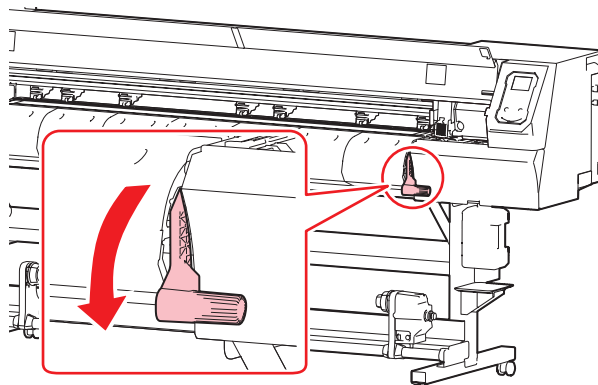

8 Secure the medium in the media holder.

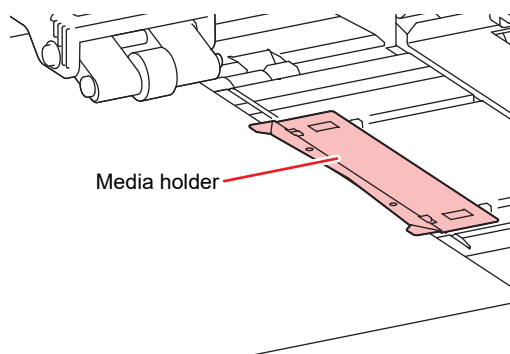

- Do not use the media holder when printing on thicker media.



- Do not use the media holder when cutting media.

9 Press  and select [LEAF].

- After the media width is detected, the rear edge of the media is detected.
- If the setting for [Machine Setup] > [Media Detect] > [Detection Type] is “MANUAL”, set the area for printing manually.



- A notification reading “Media Set Position R” will appear if the medium is too far to the right of the specified position. Reload the media.
-

10 Enter the number of pinch rollers being used.

- If the setting for [Machine Setup] > [Media Detect] > [Use PR Number Query] is “OFF”, the screen for entering the number of pinch rollers will be displayed.

2.5 Setting the Pressure and Number of Pinch Rollers to Use

Set the pressure and number used to hold media based on the tool and media being used. Incorrect pinch roller pressure settings may result in media skew or leave pinch roller marks on the media.

- 1 In LOCAL mode screen, select [PR].

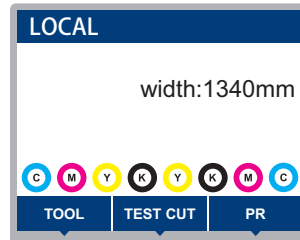

- 2 Make settings based on the tool and media used.

- The following settings can be configured:
- These settings are retained even when the power is turned off.

Item	Setting	Overview
Quantity	2 or more (depending on size)	Sets the number of pinch rollers to use.
Print setting	LOW/MID/HIGH	Sets the pressure used for printing.
Cut setting: both ends	LOW/MID/HIGH	Sets the pressure for both the pinch rollers on the edges (left and right) used for cutting.
Cut setting: center	OFF/LOW/MID/HIGH	Sets the pressure for the pinch rollers used for printing other than those on the edges.
Pullback setting: both ends	LOW/MID/HIGH	Sets the pressure for both pinch rollers on the edges (left and right) used for multilayer printing. The pinch rollers other than those on the edges are raised so that they leave no marks on the print surface. (This feature is supported in firmware version 2.5 and later.) This can be used only when printing with white ink and then with color and gloss. For more information refer to the RasterLink reference guide or the multilayer printing guide. https://mimaki.com/download/software.html https://mimaki.com/download/inkjet.html
Switch operation	-	Used to check settings. Switch to configured settings before printing the built-in pattern (e.g., test printing, test cutting).

2.6 Test Printing



Print a test pattern to confirm that the ink prints correctly.

Perform head cleaning if you observe any print defects (e.g., nozzle clogging, deflection).

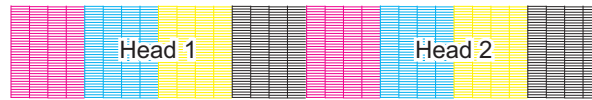
 ["Head Cleaning"\(P. 69\)](#)



Check beforehand

- Was the print head adjusted?  ["Adjusting Print Head Height"\(P. 51\)](#)
- Is media loaded?  ["Loading the Media"\(P. 57\)](#)



- Load media at least 500 mm wide. You cannot print the entire pattern if media less than 500 mm wide is used.



- Select [Maintenance] > [Nozzle Recovery] > [Test Print], then select "ON" to perform nozzle recovery and test printing. (This feature is supported in firmware version 2.5 and later)
Registration is required to perform nozzle recovery.  ["Registering nozzle recovery"\(P. 114\)](#)

Changing the Layout Direction for Test Printing

You can change the layout direction for test printing.

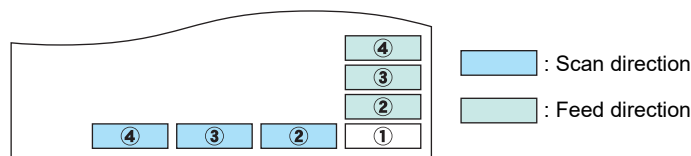

Scan direction	Prints repeatedly in the horizontal direction.
Feed direction	Feeds the medium and prints repeatedly in the longitudinal direction.

- 1** In LOCAL mode screen, select [TEST PRINT/CLEANING] > [Test Print], then press the [ENTER] key.
 - The Test Print menu is displayed.
- 2** Select "Scan direction" or "Feed direction", then press the [ENTER] key.
 - Test printing starts.

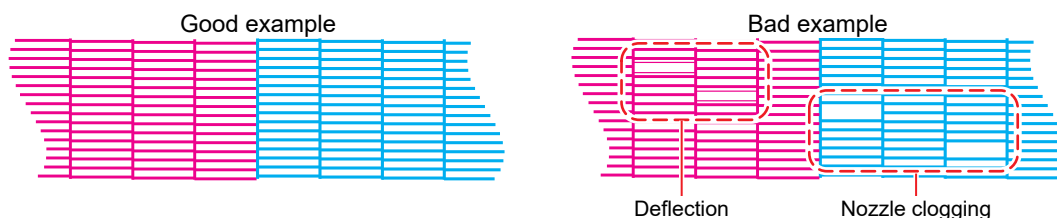

- 3** Check the print results.

Checking White Ink Ejection

The following two methods are available for checking white ink:

- Print on clear film.
- Print the background for the test pattern using black ink.

● **White Ink Confirmation Test Pattern**

1 In LOCAL mode screen, select [TEST PRINT/CLEANING] > [Test Print], then press the [ENTER] key.

- The Test Print menu is displayed.

2 Select [SpotColor Check], then press the [ENTER] key.

- Test printing starts.
- The layout direction is fixed at “Scan direction”.

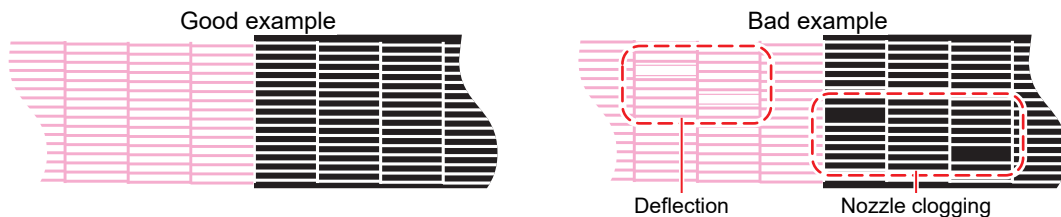

3 Check the print results.

Printing Defects

Typical examples of print defects (e.g., nozzle clogging, deflection) are as shown below. In order to prevent printing in such a state, check whether the ink has been properly ejected regularly before printing.

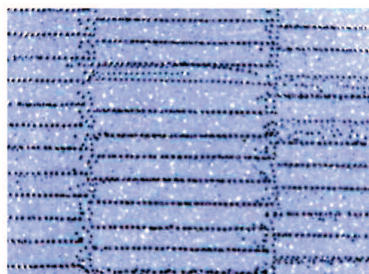

Deflection

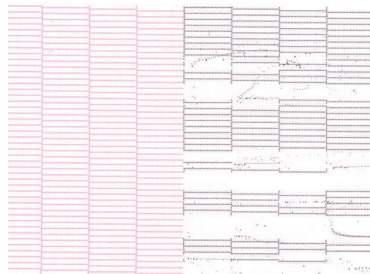

Nozzle clogging



Ink drooping



Mist

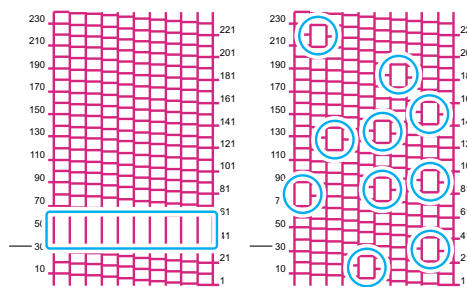

Mixing in air



2.7 Head Cleaning

The following head cleaning methods are available: Choose the method based on test results.

Item	Details
Soft	If the print shows a bent line (deflection)
Normal	If the print shows a missing line (nozzle clogging)
Hard	If soft cleaning and normal cleaning fail to resolve print defects (e.g., nozzle clogging, deflection)
Ultra	If hard cleaning fails to resolve print defects (e.g., nozzle clogging, deflection) and color mixing

- 1** In **LOCAL** mode screen, select **[TEST PRINT/CLEANING] > [Cleaning]**, then press the **[ENTER]** key.
 - The Cleaning menu is displayed.
- 2** Select the cleaning type, then press the **[ENTER]** key.
- 3** Select the Head to clean and press the **[ENTER]** key.
 - Check the check box. Heads with checked check boxes will be cleaned.
- 4** Run another test print and check the print results.
 - Repeat the cleaning and test printing process until the print results appear normal.



- Do the following if head cleaning fails to resolve the print defects (e.g., nozzle clogging, deflection).
 -  ["Wiper Cleaning"\(P. 132\)](#)
 -  ["Cap Cleaning"\(P. 134\)](#)
 -  ["Print Head Nozzle Washing"\(P. 139\)](#)

2.8 Feed Correction

Changing the media may affect the feed amount due to various factors, including the weight and thickness of the media and whether the take-up unit is used. Correct the drop position to suit the type of media used.

Image defects (e.g., dark or light streaks) will result if the feed is not properly corrected.

Check beforehand

- Is media loaded? 🖨️ "Loading the Media"(P. 57)
- For roll media, is the rear roll media free of sagging?
- When using the take-up unit, was the medium mounted on the core of the take-up unit? 🖨️ "Loading the Roll Media"(P. 57)

Feed Correction Procedure

Print a correction pattern, then enter the correction value. The value corrected here will also be updated on the settings menu.



- When using the take-up unit, load media on the take-up unit before correcting.

1 In LOCAL mode screen, select [ADJUST].

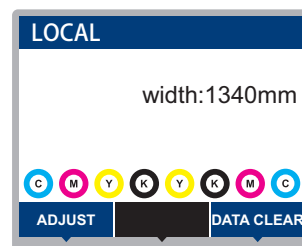

2 Select [Feed Comp.], then press the [ENTER] key.

- Correction pattern printing starts.

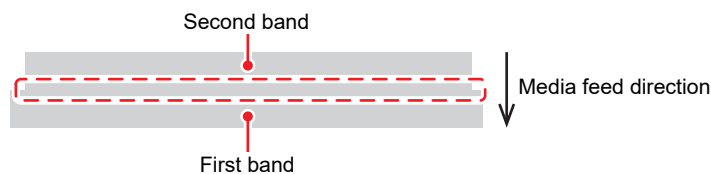

3 Check the print results.

- A correction value input screen appears.
- Adjust the bands so that the region between them is evenly colored.

4 Enter the correction value, then press the [ENTER] key.

- Enter "+" to increase the separation between bands.
- Enter "-" to reduce the separation between bands.
- Increment the correction value by "30" to move the bands by approximately 0.1 mm.

5 Press the [ENTER] key.

- Print another correction pattern to check.



- Once adjustment is complete, the medium will be fed to the print origin. Sagging may occur in the rear roll medium. Rewind roll media by hand to eliminate any sagging.

Correcting the Media Feed During Printing

You can also correct the media feed amount in REMOTE mode or while printing.

- 1** Press [ADJUST] in REMOTE mode or while printing.
- 2** Enter the correction value, then press the [ENTER] key.
 - Correction value: -9999 to 9999
 - The value entered here will be updated immediately.

2.9 Correcting the Drop Position

Changing the media and print head height will also alter the drop positions. Correct the drop position to suit the type of media used.

Image defects (e.g., overlaid lines or blurred images) will result if the drop position is not properly corrected.

Check beforehand

- Was the print head adjusted? 🧠 ["Adjusting Print Head Height"\(P. 51\)](#)
- Is media loaded? 🧠 ["Loading the Media"\(P. 57\)](#)



- Load media at least 500 mm wide. You cannot print the entire pattern if media less than 500 mm wide is used.

Drop Position Correction Procedure

Print a correction pattern, then enter the correction value. The value corrected here will also be updated on the settings menu.

1 In LOCAL mode screen, select [ADJUST].

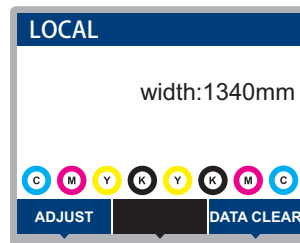

2 Select [Drop.PosCorrect], then press the [ENTER] key.

- Correction patterns for all resolutions will be printed.



- The indicated resolutions are those in the scan direction.

3 Check the print results.

- A correction value input screen appears.
- Enter the position where the two upper and lower lines coincide.

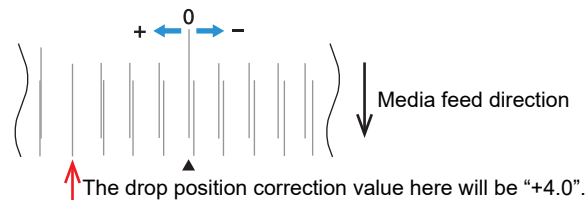

4 Enter the correction value, then press the [ENTER] key.

- Correction value: -40 to 40







- If the lines do not coincide when the correction value is within the range -40 to 40, the print head height may have been improperly adjusted. Adjust the print head height. 🧠 ["Adjusting Print Head Height"\(P. 51\)](#)

5 Enter the correction value in the same way for pattern 2 and subsequent patterns.

2.10 Printing RIP Data

Check beforehand

- Was the head gap adjusted?  ["Adjusting Print Head Height"\(P. 51\)](#)
- Were the pinch roller positions adjusted?  ["Adjusting the Pinch Roller Positions"\(P. 52\)](#)
- Is media loaded?  ["Loading the Media"\(P. 57\)](#)
- Was the pinch roller pressure adjusted?  ["Setting the Pressure and Number of Pinch Rollers to Use"\(P. 66\)](#)
- For roll media, is the rear roll media free of sagging?
- When using the take-up unit, was the medium mounted on the core of the take-up unit?  ["Loading the Roll Media"\(P. 57\)](#)

Preparing RIP Data

The explanation here applies to MIMAKI RIP software (RasterLink).



- Prepare suitable image data for printing.

1 Launch RasterLink.

- Click the icon on the PC desktop.



2 Select the image data to print.

- (1) Select [File] > [Open].
- (2) Select the desired image data, then click [Open].
 - If multiple printers are registered, select UCJV300 Series, 150 Series in "Printer name".

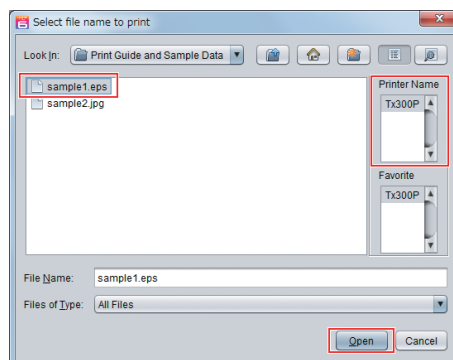

3 Select the image data imported.

- The image is displayed in the tab for UCJV300 Series, 150 Series selected in “Printer name”.

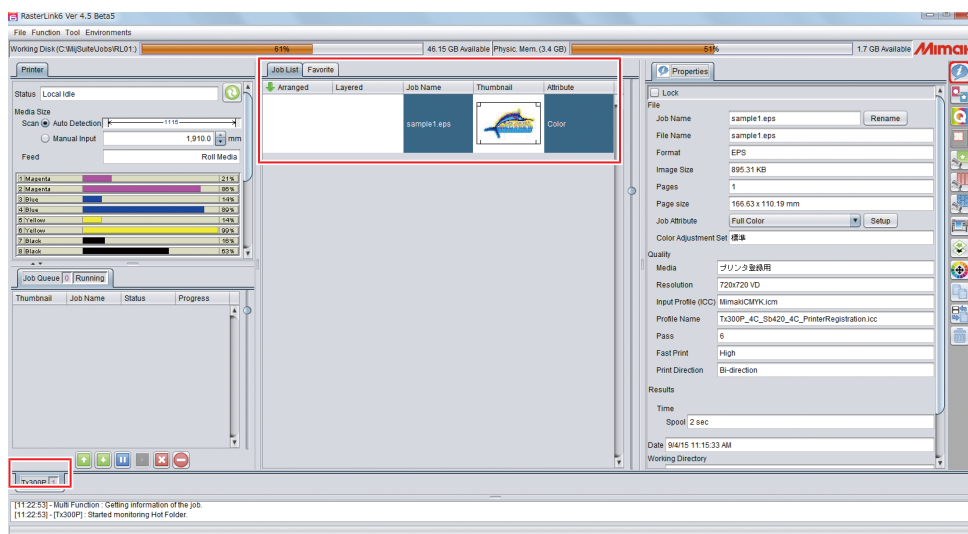

4 Check the settings and alter as necessary.

- Specify the following settings by clicking the function icons shown on the right-hand side of the screen:



(normal printing): Specifies settings like enlargement/reduction and number of copies.



(print conditions): Selects a color profile for the media and ink set loaded in this machine.



- For more information, refer to the RasterLink reference guide.

<https://mimaki.com/download/software.html>

5 Print image data.



- Click (execute) from the function icons on the right-hand side of the screen. Select “Immediate Print” or “RIP and Print”, then click [Start].



- Media width must be reacquired after replacing media.
 - Select the tab for UCJV300 Series, 150 Series in the main window.
 - Click (display latest printer status) in the Printer tab.

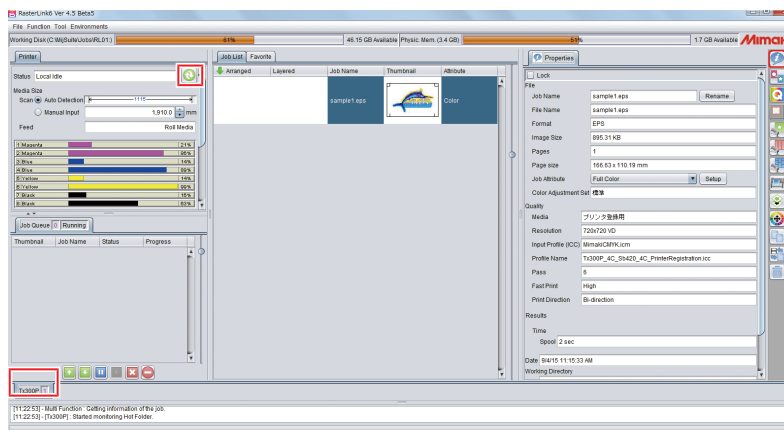

Changing the Origin

The print start position can be altered. Use the LED pointer to set the origin.

- Print origin default value
 - Feed (longitudinal, X') direction: Approx. 75 mm to rear from platen cutting slot
 - Scan (lateral, Y') direction: 15 mm from right edge of media

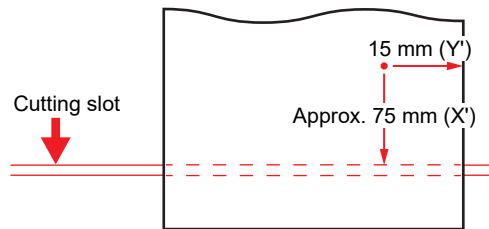

1 In LOCAL mode, press ▲▼◀▶.

- The Origin Setup screen appears.

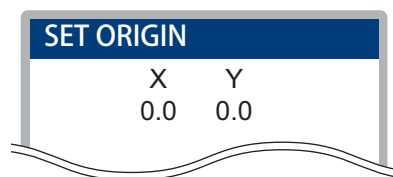

2 Press ▲▼◀▶ to move the origin to the desired position.

- The carriage moves left and right and feeds the medium.

3 Press the [ENTER] key.

- The origin is updated.

Starting Printing

1 Press [REMOTE].

- The machine switches to REMOTE mode and is ready for printing.

2 Send the RIP data from the PC.

- ["Preparing RIP Data"\(P. 73\)](#)



- If an error message appears, check appropriate actions by referring to the error number. ["Error messages"\(P. 175\)](#)

3 Start printing.

- Printing starts once RIP data is received.

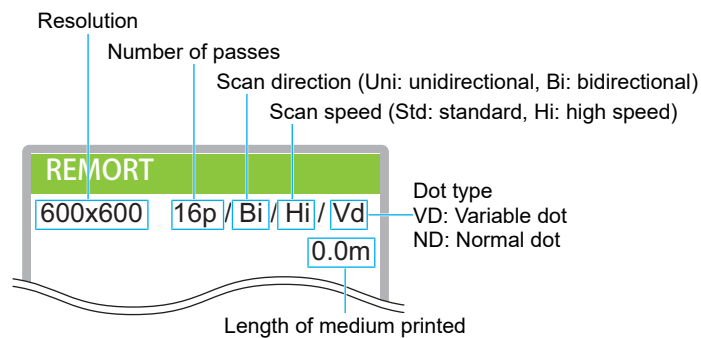

- Print speeds may differ for the same image data, depending on the width of the medium loaded, print origin position, and resolution.
- If an error occurs, the machine switches to LOCAL mode once printing is completed. Further printing is not possible.

Pausing Printing

1 Press [LOCAL] while printing is in progress.

- Printing is paused.
- If data is being sent from a PC, data transmission is paused at the PC.

2 Press [REMOTE].

- Printing resumes.



- No other functions can be used when printing is paused.

Stopping Printing (Data Clear)



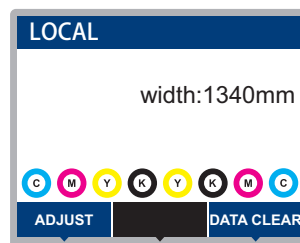

1 In LOCAL mode screen, select [DATA CLEAR].





2 Press the [ENTER] key to clear the received data.

- The receive buffer is cleared.

2.11 Cut the media.

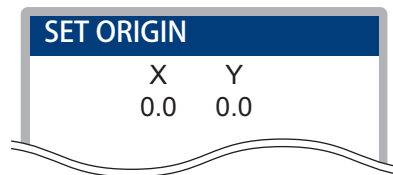
- 1 In LOCAL mode, press    .
 - The Origin Setup screen appears.



- 2 Press   to feed the media to the position required for cutting.
- 3 Select [CUT], then press the [ENTER] key.
 - The medium is cut.

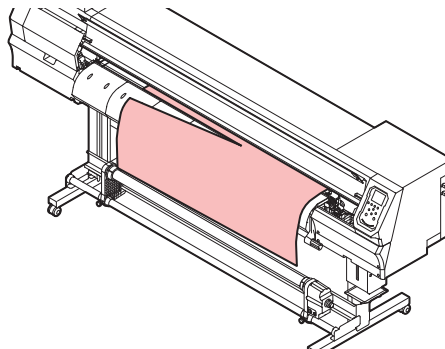

Chapter 3 Cutting



This chapter

This chapter explains the cutting function.

Cutting Process	80	Test Cutting	91
Installing Cutting Tools	82	Cutting the Cutting Data	92
Using the Cutter	82	Changing the Origin	92
Using a Pen.....	86	Starting Cutting	92
Setting the Cutting Conditions.....	90	Stopping Cutting (Data Clear).....	93
		Retracting the Cutter Unit	93

3.1 Cutting Process

1. Turn on the power.

 ["Turning On the Power"\(P. 32\)](#)

2. Connect this machine to the PC on which the cutting software is installed.

 ["Using a USB 2.0 Interface Cable"\(P. 34\)](#)

 ["Using a LAN Cable"\(P. 34\)](#)

3. Adjust the pinch roller positions.

Adjust the pinch roller positions to suit the width of the set media. Adjust the pinch roller positions so that the pinch rollers are positioned above the grit rollers. The pinch rollers at both ends should be aligned to within 10 cm from the left edges and 2 cm from the right edges of the media.  ["Adjusting the Pinch Roller Positions"\(P. 52\)](#)

4. Load the media.

This machine can be used with roll media and leaf media.  ["Loading the Media"\(P. 57\)](#)

5. Adjust the number and pressure of pinch rollers to use.

Set an appropriate pressure for the set media.  ["Setting the Pressure and Number of Pinch Rollers to Use"\(P. 66\)](#)

6. Install cutting tools.

This machine can be used with a cutter and a pen (ballpoint pen).  ["Installing Cutting Tools"\(P. 82\)](#)

7. Set the cutting speed and pressure.

Set the cutting speed and pressure to match the type of media and tools in use. Setting the Cutting Conditions

8. Perform test cutting.

Perform a test cut to confirm that the tool conditions are set appropriately.  ["Test Cutting"\(P. 91\)](#)

9. Set the cutting data.



 ["Cutting the Cutting Data"\(P. 92\)](#)

10. Cut the media.

 ["Cut the media."\(P. 77\)](#)

3.2 Installing Cutting Tools

This machine can be used with the following tools:

- Cutter (for cutting media)
Used to cut the printed image on media or to cut characters with the cutting sheet
 "Using the Cutter"(P. 82)
- Pen (ballpoint pen)
Used to adjust register marks This machine can be used with a ballpoint pen or cartridge refill.
 "Using a Pen"(P. 86)

Using the Cutter

Installing the Cutter in the Cutter Holder

Be careful to keep the cutter from falling into a gap in this machine. We recommend replacing the cutter on the media so you can easily pick up the cutter blade if it falls.



- Avoid touching the cutter blade. Doing so may lead to injury.
- Do not shake or swing the cutter holder. Doing so may cause the blade to come off.



- Do not store in places accessible to children.



- When disposing of the product, contact an industrial waste disposal operator or dispose of the product in accordance with the local laws and regulations.

1 Remove the cap from the cutter holder.

- Turn in the direction indicated by the arrow in the picture.

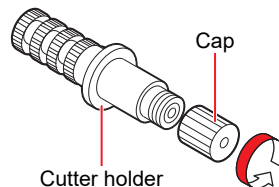

2 Insert the cutter into the cutter holder.

- Use tweezers to insert the cutter.

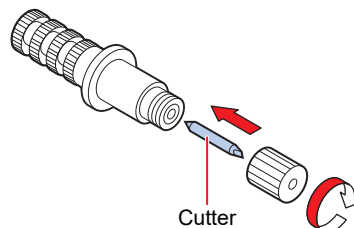

3 Fix the cap by turning in the direction indicated by the arrow in the picture.

Adjusting the Cutting Blade Protrusion Length

Adjust the cutting blade protrusion length (0.2 to 0.5 mm).

- If the base paper is thicker than the label film: $(\text{label film thickness} + \text{base paper thickness})/2$

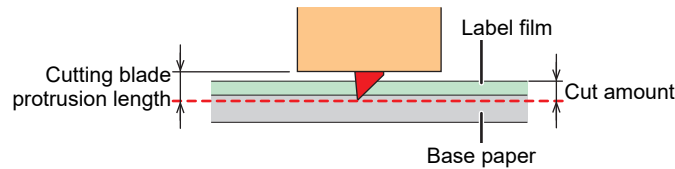

- If the base paper is thinner than the label film: As far as to cut into label film

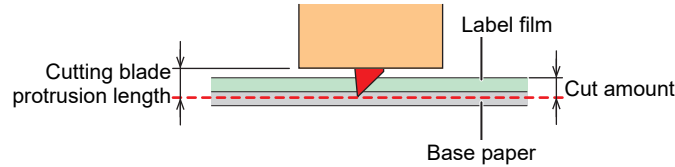

- An option is available to accurately adjust the protrusion amount of the blade tip.
Part number: OPT-C0066 "blade adjuster (for eccentric cutter)"

1 Turn the adjusting knob to adjust the protrusion of the cutting blade.

- Turn the adjusting knob in the direction indicated by the arrow in the picture to have the blade protrude. (0.5 mm per turn)

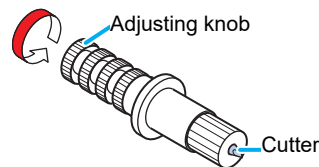

2 Check the cutting performance.

- Adjust the pressure so that it leaves slight marks on the base paper. A cutting blade that protrudes too far may damage the machine.

["Setting the Cutting Conditions"\(P. 90\)](#)

["Test Cutting"\(P. 91\)](#)



- When using the cutter holder included in the delivery, you can adjust the protrusion length while the cutter is attached to the tool holder. (0.5 mm per turn of the adjusting knob)

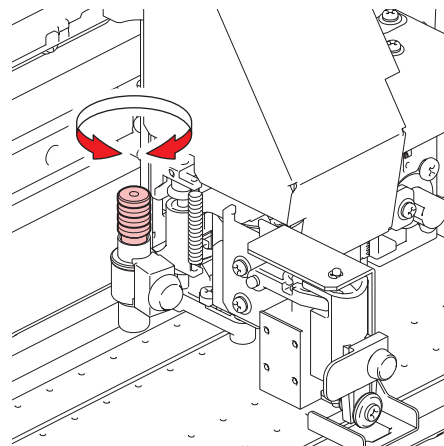

Installing the Cutter Holder

1 In LOCAL mode, select [MENU] > [CUTTING], then press the [ENTER] key.

- The Cutting menu is displayed.

2 Select [TOOL CHANGE], then press the [ENTER] key.

- The cutter unit moves over the platen.

3 Open the front cover.

- The cutter unit can be moved manually. Move the cutter unit slowly to a position that allows easy access for installing the cutter holder.

4 Turn the knob screw and loosen the holder presser.

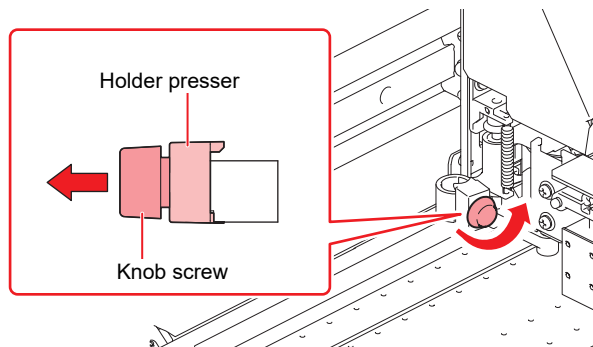

5 Insert the cutter holder into the tool holder.

- (1) Push the brim of the cutter holder against the tool holder.
- (2) Put the brim of the cutter holder into the tool holder.

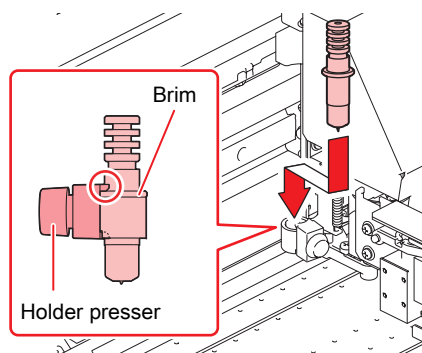

6 Secure the cutter holder.

- Turn the knob screw and fix the holder presser.
- Failure to secure firmly may result in lower quality.

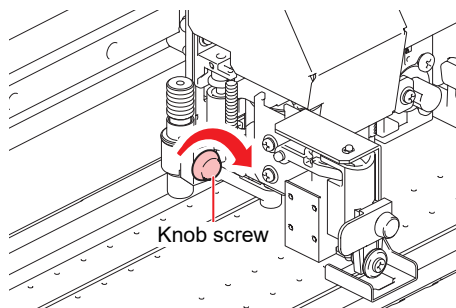

7 Press the [ENTER] key once installation is complete.

8 Close the front cover.

Using the Included Cutter Holder (SPA-0001)

- 1** Loosen the lock nut of the cutter holder and extract the adjusting knob.
 - Turn in the direction indicated by the arrow in the picture.

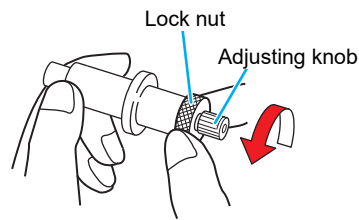

- 2** Insert the cutter into the adjusting knob,
 - Use tweezers to insert the cutter.

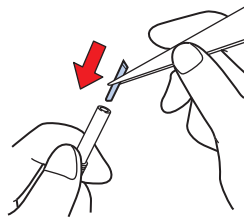

- 3** Fix the lock nut by turning in the direction indicated by the arrow in the picture.



Adjusting the Cutting Blade Protrusion Length

- 1** Loosen the lock nut of the cutter holder.

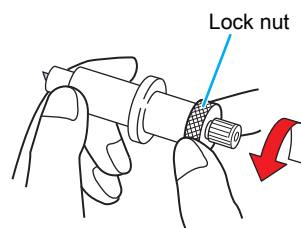

- 2** Turn the adjusting knob to adjust the protrusion of the cutting blade.

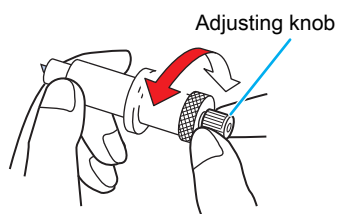

- 3 Fix the lock nut by turning in the direction indicated by the arrow in the picture.



Using a Pen

Installing a Refill Cartridge for a Ballpoint Pen in the Pen Holder

The image quality can vary depending on the type of refill cartridge.
Recommended: SXR-5 (Mitsubishi Pencil Co., Ltd.)

- 1 Remove the cap from the pen holder.

- Turn in the direction indicated by the arrow in the picture.

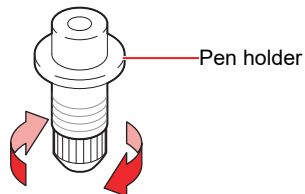

- 2 Insert a refill cartridge for a ballpoint pen in the pen holder.

- Insert the refill cartridge until it hits the pen holder.

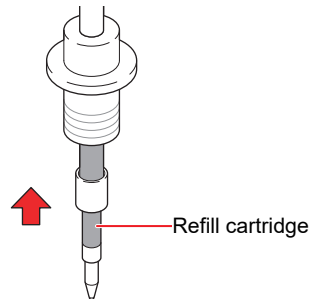

- 3 Fit the refill cartridge to the spring.

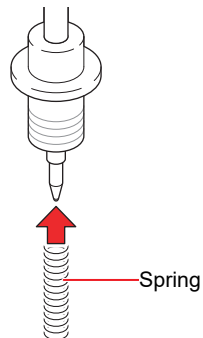

- 4** Fix the cap by turning in the direction indicated by the arrow in the picture.

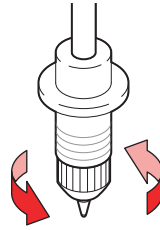

Installing a Ballpoint Pen in the Pen Holder

Use a ballpoint pen with a diameter of 8 to 9 mm. The ballpoint pen type may affect image quality. Recommended: K105-GA (Pentel Co., Ltd.)



- Do not use ballpoint pens as shown below. Some types of ballpoint pens may tilt.



Pens with shafts that change thickness midway

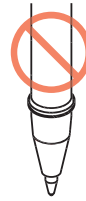

Pens with protrusions or bumps on the shaft

- 1** Put the cap on the pen adapter.

- The cap is used to adjust the height of the pen nib.

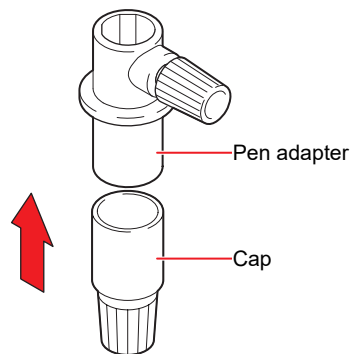

- 2** Insert the ballpoint pen into the pen adapter.

- Insert the pen nib until it hits the cap.

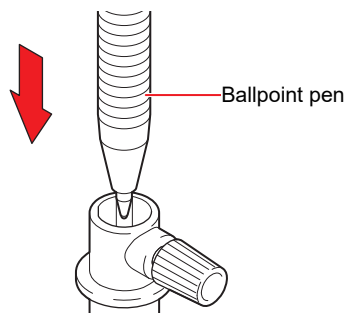

3 Fix the pen nib by turning the knob screw in the direction indicated by the arrow in the picture.

- Be careful to avoid overtightening the knob screw. Disregarding this precaution may damage or break the ballpoint pen.

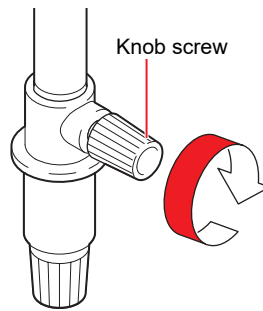

4 Remove the cap.

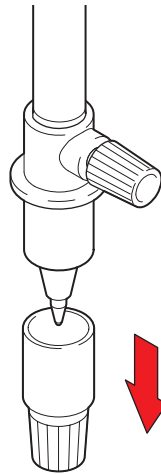

Installing a Pen

1 In LOCAL mode, select [MENU] > [CUTTING], then press the [ENTER] key.

- The Cutting menu is displayed.

2 Select [TOOL CHANGE], then press the [ENTER] key.

- The cutter unit moves over the platen.

3 Open the front cover.

- The cutter unit can be moved manually. Move the cutter unit slowly to a position that easy access for installing the cutter holder.

4 Turn the knob screw and loosen the holder presser.

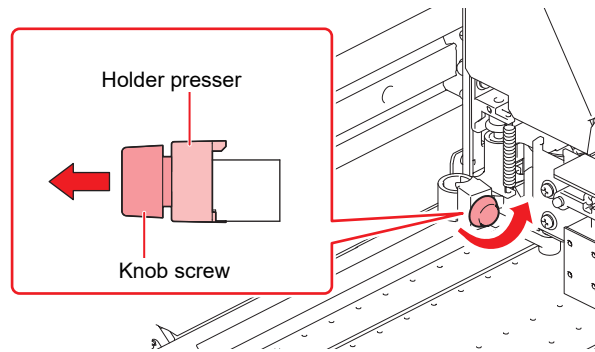

5 Insert the pen holder or pen adapter into the tool holder.

- (1) Push the brim of the pen holder or pen adapter against the tool holder.
 - Position the pen adapter so that the knob screw is easily accessible.
- (2) Push the brim of the pen holder or pen adapter against the holder presser.

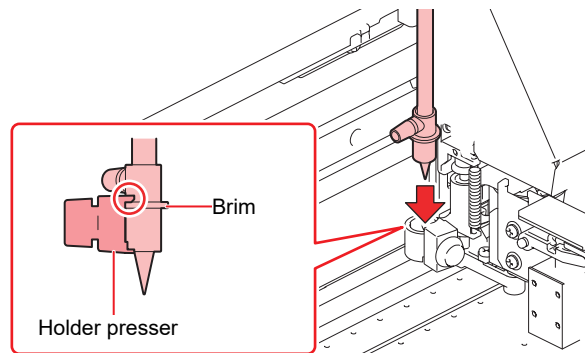

6 Secure the pen holder or pen adapter.

- Turn the knob screw and fix the holder presser.
- Failure to fix securely may result in lower quality.

7 Press the [ENTER] key once installation is complete.

8 Close the front cover.

3.3 Setting the Cutting Conditions

You can set the cutting speed and pressure to match the type of media and tools in use.

- 1 In LOCAL mode screen, select [TOOL].

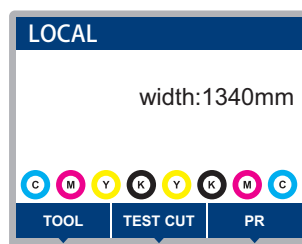

- 2 Set the conditions.

- The following items can be configured:
- The settings are retained even when the power is turned off.

Item	Setting	Outline
TOOL	CUT1 to 7/ PEN	<ul style="list-style-type: none"> • Press the key repeatedly to change the tool condition in the sequence shown below.
Speed	1 to 20 cm/s	<ul style="list-style-type: none"> • Sets the speed for cutting or pen writing.
Pressure	TOOL: 10 to 450 g PEN: 10 to 150 g	<ul style="list-style-type: none"> • Sets the pressure for cutting or pen writing. • This setting is also required for half cuts.
Offset ^{*1}	0.00 to 2.50 mm	<ul style="list-style-type: none"> • Sets the length from the center of the cutter holder to the cutting blade.
HALF CUT ^{*1}	ON/OFF	<ul style="list-style-type: none"> • Cuts across a dotted line without cutting out the base paper. <ul style="list-style-type: none"> • If HALF CUT is set to "ON", the three items listed below are displayed: Set the following three items and pressure in the Cutting Conditions menu:
Half cut pressure	0 to 300 g	<ul style="list-style-type: none"> • Sets the pressure for the uncut portion.
Uncut length	0.1 to 5.0 mm	<ul style="list-style-type: none"> • Sets the uncut length.
Cut length	5 to 150 mm	<ul style="list-style-type: none"> • Sets the cut length.

1. This cannot be set when PEN is selected.

3.4 Test Cutting

Execute test cutting to confirm that the tool conditions are set appropriately.

Increase pressure as the cutter blade grows dull with wear. This is only a temporary measure. We recommend replacing the cutter blade to maintain cutting quality.

- 1 In LOCAL mode screen, select [TEST CUT].

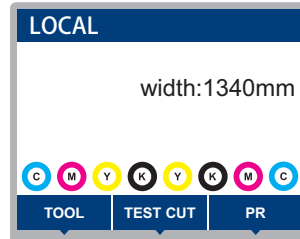

- 2 Select [Test Cut], then press the [ENTER] key.

- Test cutting starts.

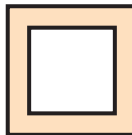





- Check the test cut results, and change the cutting conditions accordingly.

Symptom	Cause	Solution
An uncut section was identified.	<ul style="list-style-type: none"> • Because the speed is too high, the cutting blade passed over the media. 	<ul style="list-style-type: none"> • Reduce the speed. ☞ "Setting the Cutting Conditions"(P. 90) • Tighten the knob on the tool holder. ☞ "Installing the Cutter Holder"(P. 83)
The base paper of the media is cut.	<ul style="list-style-type: none"> • The pressure is excessive. • The cutting blade protrudes too far. 	<ul style="list-style-type: none"> • Reduce pressure. ☞ "Setting the Cutting Conditions"(P. 90) • Reduce the protrusion of the cutting blade. ☞ "Adjusting the Cutting Blade Protrusion Length"(P. 82)
The corners are rounded.	<ul style="list-style-type: none"> • The length from the center of the cutter holder to the cutting blade is not set correctly. 	<ul style="list-style-type: none"> • Adjust the [Offset] value according to the cutter used. ☞ "Setting the Cutting Conditions"(P. 90)
The corners are turned up.	Two or more of the following apply: <ul style="list-style-type: none"> • The cutting blade protrudes too far. • The pressure is excessive. • The [MENU] > [CUTTING] > [SETUP SUB MENU] > [ADJ-PRS OFFSET] value is large. 	<ul style="list-style-type: none"> • Reduce the protrusion of the cutting blade. ☞ "Adjusting the Cutting Blade Protrusion Length"(P. 82) • Reduce pressure. ☞ "Setting the Cutting Conditions"(P. 90) • Reduce the [ADJ-PRS OFFSET] value. ☞ "Cutting Menu"(P. 124)

3.5 Cutting the Cutting Data

Check beforehand

- Was the head gap adjusted?  "Adjusting Print Head Height"(P. 51)
- Were the pinch roller positions adjusted?  "Adjusting the Pinch Roller Positions"(P. 52)
- Is media loaded?  "Loading the Media"(P. 57)
- Are the pinch rollers configured?  "Setting the Pressure and Number of Pinch Rollers to Use"(P. 66)

Changing the Origin

You can change the cutting start position. Use the LED pointer to set the origin. The origin set here will be the origin of the cutting software you are using.

When cutting the same data again, change the origin. If not, cutting starts at the same position.

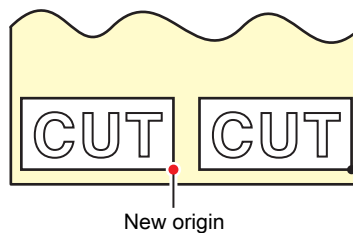

1 In LOCAL mode, press .

- The Origin Setup screen appears.

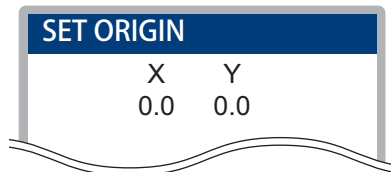

2 Press to move the origin to the desired position.

- The carriage moves left and right and feeds the medium.

3 Press the [ENTER] key.

- The origin is updated.
- The set tool conditions are displayed on the display.

Starting Cutting

1 Press [REMOTE].

- The machine switches to REMOTE mode and is ready for cutting.

2 Send the cutting data from the PC.



- For more information, refer to the operation manual of the cutting software you are using.

3 Cutting starts.

- Cutting starts once the cutting data is received.
- The remaining amount of data is displayed on the display.



- If the media moves out of place during cutting, immediately turn off the power. Continuing to cut while the media is not in place may damage the machine.

Pausing Cutting

1 Press [LOCAL] while cutting is in progress.

- Cutting is paused.
- If data is being sent from a PC, data transmission is paused at the PC.

2 Press [REMOTE].

- Cutting resumes.



- No other functions can be used while printing is paused.

Stopping Cutting (Data Clear)

1 In LOCAL mode screen, select [DATA CLEAR].

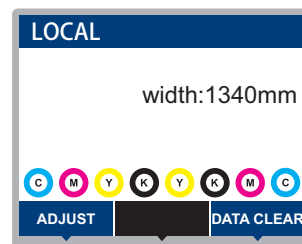

2 Press the [ENTER] key to clear the received data.

- The receive buffer is not cleared.

Retracting the Cutter Unit

When cutting or printing-with-a-pen is completed, the cutter unit is positioned on the platen. To check the cutting result or to set new media, retract the cutter unit from the platen.

1 In LOCAL mode screen, select [TEST CUT].

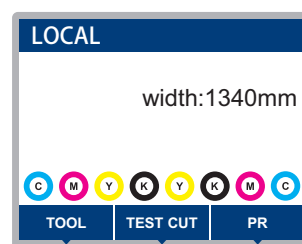

2 Select [Move/Retract Cutter], then press the [ENTER] key.

- The cutter unit moves to the maintenance space on the left side of the machine.
- When the connecting unit is connected to the carriage, confirm the connection before moving the cutter unit to the origin. (Cutter unit moves)

Chapter 4 Try cutting data with registration marks



This chapter

Describes the conditions for creating registration marks and basic information.

Process for Cutting Data with Register Marks	96	Setting Mark Detection Conditions	103
Creating Register Marks	98	Detecting the Position of the Register Mark	
Register marks	98	Origin	104
Register Mark Size	99	ID Cut Process	105
Spacing Between Register Marks	99		
Reading Range of Register Marks	100		
No-Plotting Areas Around Register Marks	102		
Combined Operations of Printing and Cutting	102		

4.1 Process for Cutting Data with Register Marks

1. Create data with register marks.

 ["Creating Register Marks"\(P. 98\)](#)

This machine can detect the following three types of register marks:

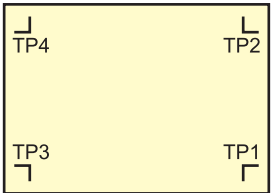
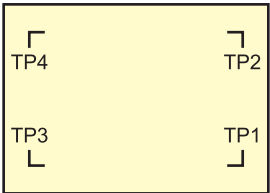
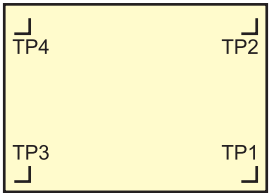
Mark shape		
Type 1	Type 2	Zero margin register mark
		

2. Print printing data with register marks.

 ["Print Process"\(P. 48\)](#)

3. Prepare for cutting.

 ["Cutting Process"\(P. 80\)](#) (Steps 4 to 8)

4. Register the information for the printed register marks.

 ["Setting Mark Detection Conditions"\(P. 103\)](#)

5. Detect the register mark origin.

 ["Detecting the Position of the Register Mark Origin"\(P. 104\)](#)

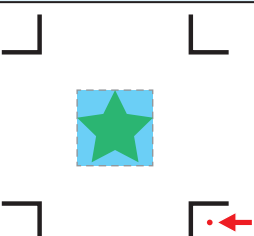
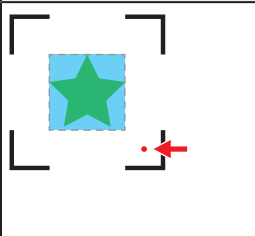
Mark shape	
Type 1	Type 2
	

6. Cut the data.

👉 "Cutting the Cutting Data"(P. 92)

7. Cut the media.

👉 "Cut the media."(P. 77)



4.2 Creating Register Marks

Printing image data with “register marks” can increase cutting accuracy and quality. There are some limitations to register marks. Read the following thoroughly before creating register marks.

Trimming register marks cannot be used with this machine.

Register marks

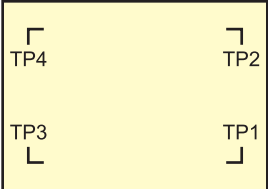
The following three types of register marks can be used with this machine:

Mark shape		
Type 1	Type 2	Zero margin register mark
		



- Use mark 4 (TP4) to perform trapezoidal corrections. Mark 4 can be skipped, but doing so will reduce cutting accuracy.
Trapezoidal correction: Corrects the difference between the right and left feed amount of the media.

Media and Register Mark Color

We recommend using white media and black register marks. The machine may fail to detect register marks in other colors.

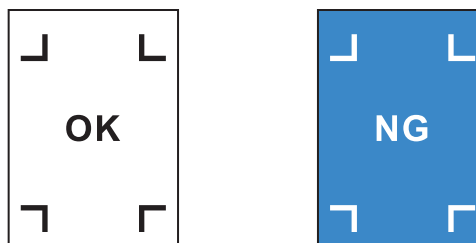

Blurred Register Marks

Ensure that printed register marks are not blurred. If the register marks are blurred, the mark origins may be incorrectly identified, or the machine may fail to detect the register marks.



Register Mark Size

The recommended register mark size (A) is within the range of A4 size (210 mm x 297 mm) to A3 size (297 mm x 420 mm). If the dimensions exceed A3, the machine may fail to detect register marks due to media feeding problems (e.g., media meandering).

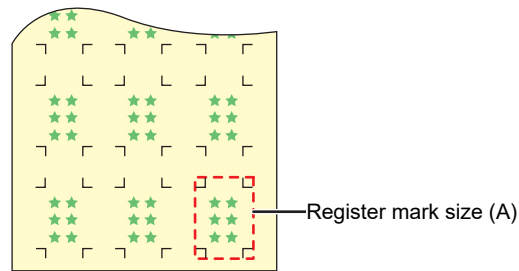

Standards for Register Mark Length and Line Width

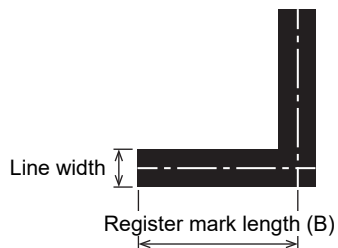

The recommended register mark length and line width are as shown below. The machine may fail to detect register marks that lie outside the recommended range.

Register mark size (A)	Register mark length (B)	Line width
200 mm or less	5 mm	0.5 mm
201 to 500 mm	8 mm	
501 to 1,000 mm	15 mm	1.0 mm
1,001 to 2,000 mm	25 mm	
2,001 mm or more	35 mm	

- If the “Fill around the register mark” function of the RIP software is enabled, the register mark length (B) should be 10 mm or more.

When Printing Register Marks Continuously

The register mark length (B) should be 8 mm or more. The machine may fail to detect register marks less than 8 mm if it reads them continuously.

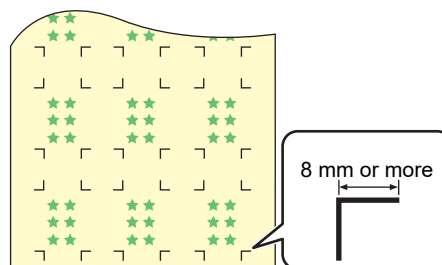

Spacing Between Register Marks

The spacing between register marks (C) is as shown below.

Mark shape	
Type 1	Type 2
Register mark length $(B) \times 2 + \alpha$, up to 1,000 mm	Register mark length $(B) + \alpha$, up to 1,000 mm

● **Mark Origin Mis-detection Example**

- If the spacing between register marks (C) is narrow, as shown in the figure below, the machine may fail to detect them.

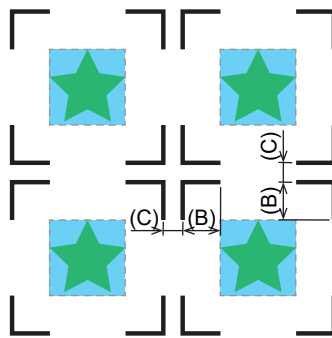

Reading Range of Register Marks

This machine can detect register marks in the range shown below. If the margin is small, the edge of the media may be incorrectly identified as a register mark.

When copying data with MIMAKI RIP software (RasterLink), leave a space of at least 210 mm from the rear edge of the media.

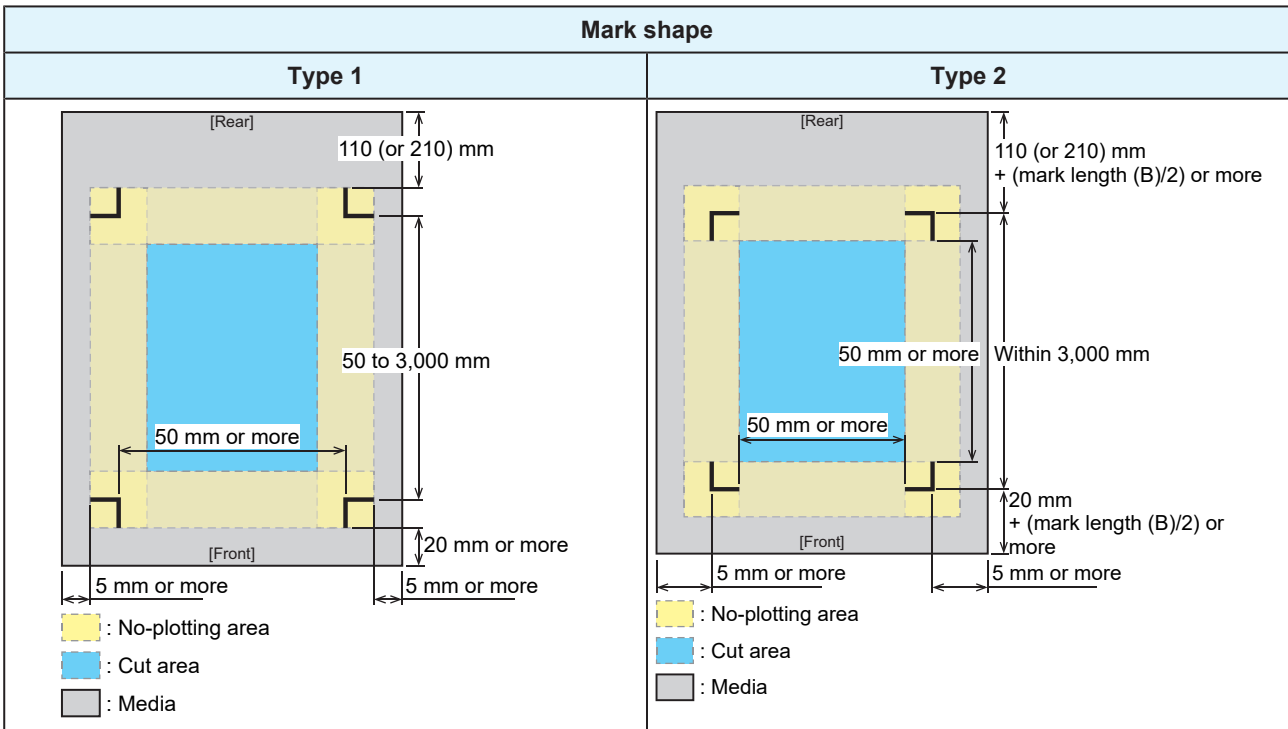

ID Cut

This machine can detect register marks in the range shown below. If the margin is small, the edge of the media may be incorrectly identified as a register mark.

When copying data with MIMAKI RIP software (RasterLink), leave a space of at least 210 mm from the rear edge of the media.

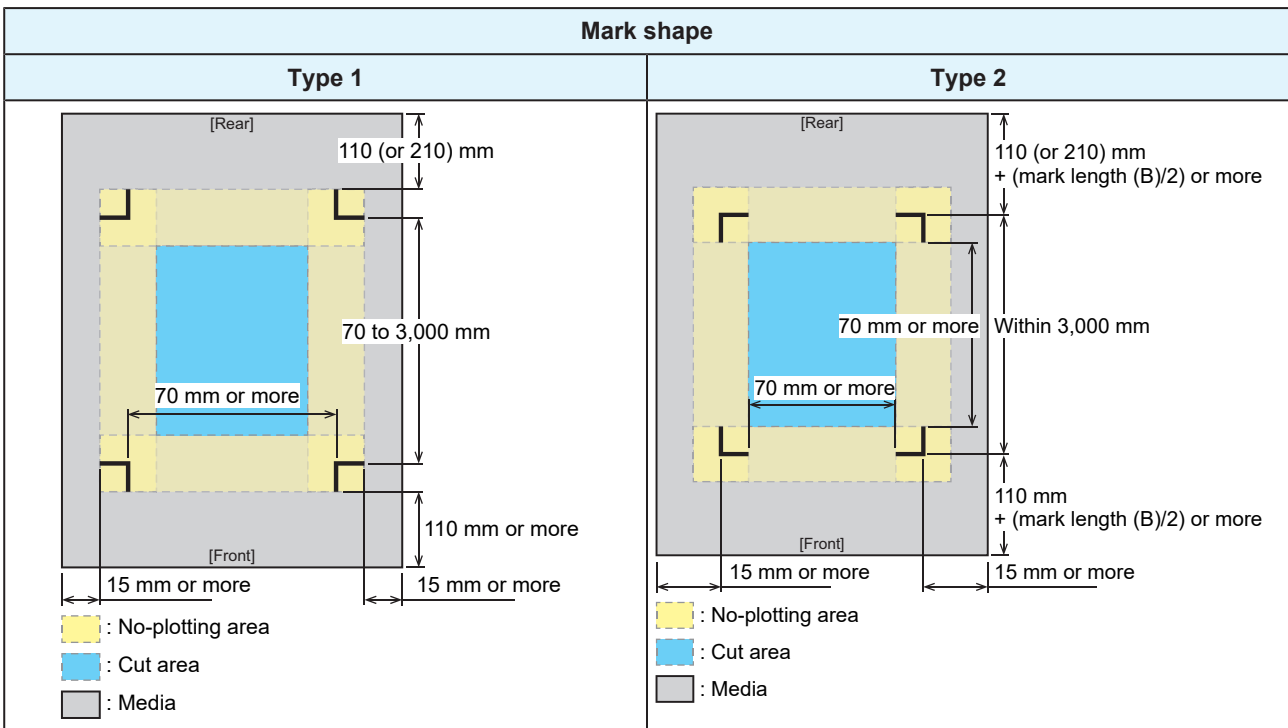

- For more information, refer to the ID Cut Guide.
<https://mimaki.com/download/software.html>

No-Plotting Areas Around Register Marks

Do not plot data around register marks. The mark origins may be identified incorrectly, or the machine may fail to detect the register marks.

Mark shape	
Type 1	Type 2
<p> : No-plotting area : Plotting area </p>	<p> : No-plotting area : Plotting area </p>

● Mark Origin Mis-detection Example

- If register marks are plotted in the no-plotting area as shown in the figure below, the line may be incorrectly identified as a register mark.

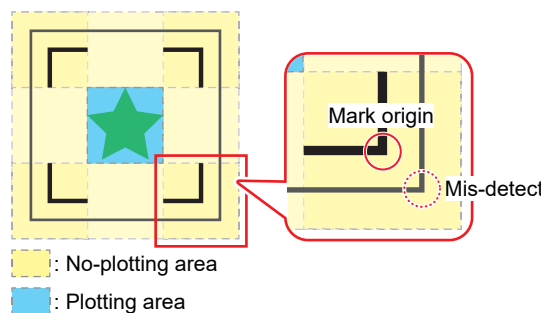

Combined Operations of Printing and Cutting

When printing and cutting with MIMAKI RIP software (RasterLink, FineCut), please note the following:

- The mark size and mark shape settings configured in the machine will be disregarded. The software settings will be applied.
- We recommend printing and cutting using data with register marks. The volume of print data may affect cutting accuracy.
- Although it is possible to print and cut data without register marks using take-up units, doing so may reduce cutting accuracy.

4.3 Setting Mark Detection Conditions

Set the conditions of the printed register marks.

1 In LOCAL mode screen, select [MENU] > [CUTTING], then press the [ENTER] key.

- The Cutting menu is displayed.

2 Select "TP DETECT", then press the [ENTER] key.

- The Mark Detect menu is displayed.



- The Mark Detect menu can also be displayed as follows:

(1) In LOCAL mode screen, select [TEST CUT].

(2) Select [TP Detect Setup], then press the [ENTER] key.

3 Select and set the items.

-  ["Cutting Menu List"\(P. 124\)](#)

4.4 Detecting the Position of the Register Mark Origin

- 1 In LOCAL mode screen, select [TEST CUT].

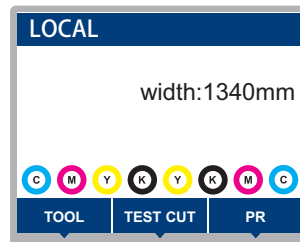

- 2 Select [Mark Detection], then press the [ENTER] key.

- The machine switches to TP DETECT mode.
- The cutting unit moves over the platen.



- If the machine does not switch to TP DETECT mode, set the [TEST CUT] > [TP Dect Setup] > [TP DETECT] setting to "ON".

- 3 Press to move the LED pointer to the center of the register mark.

Mark shape	
Type 1	Type 2

- 4 Press the [ENTER] key.

- Register mark detection starts.

4.5 ID Cut Process

1. Create data with ID Cut.



- For more information, refer to the ID Cut Guide.
<https://mimaki.com/download/software.html>

2. Print printing data with ID Cut.

"Print Process"(P. 48)

3. Prepare for cutting.

"Cutting Process"(P. 80) (Steps 4 to 8)

4. Register the information for the printed register marks.

"Setting Mark Detection Conditions"(P. 103)

5. Detect the register mark origin.

"Detecting the Position of the Register Mark Origin"(P. 104)

6. Cut the data.

"Cutting the Cutting Data"(P. 92)

7. Cut the media.

"Cut the media."(P. 77)

Chapter 5 Settings



This chapter

This chapter describes the various setting procedures.

Setup menu	108	Nozzle Check Menu	122
Temporary Use	108	Nozzle Check Menu List	122
Setup Menu List	109	Information Menu	123
Maintenance Menu	113	Information Menu List	123
Maintenance Menu List	113	Cutting Menu	124
Machine Setup Menu	117	Cutting Menu List	124
Machine Setup Menu List	117		

5.1 Setup menu

Print conditions (settings 1 to 4, Temporary) can be saved in advance for specific media. To set print conditions for a single use, select "Temporary". The conditions set in "Temporary" will not be saved.

● Setup menu screen

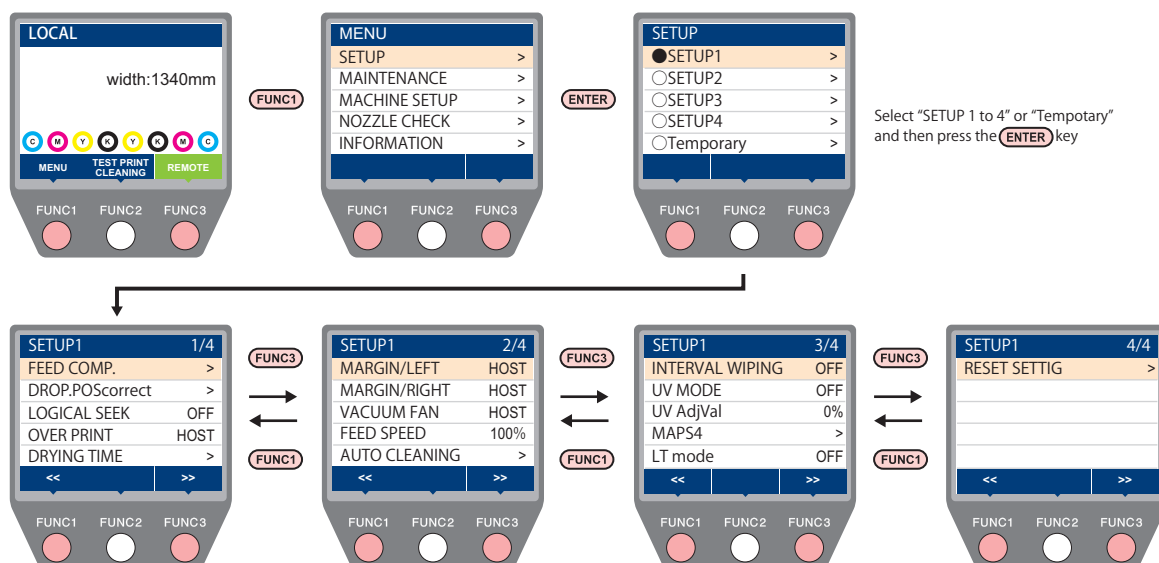

Temporary Use

"Temporary" is used to set print conditions for a single use. This is also useful if you only want to use some of the settings 1 to 4. The "Temporary" printing conditions can be saved to Settings 1 to 4.



- The conditions set in "Temporary" are cleared and "Setting 1" is active when the machine is restarted.

● To copy Settings 1 to 4 to "Temporary"

You can edit Settings 1 to 4 to set print conditions for single use.

- 1** In LOCAL mode, select [MENU] > [Setup], then press the [ENTER] key.
 - The setting types are displayed.
- 2** Select [Temporary].
 - The Setup menu is displayed. "Setup Menu List"(P. 109)
- 3** Select [SETUP RESET] and press the [ENTER] key.
- 4** Select [COPY], then press the [ENTER] key.
 - The copy source selection screen is displayed.
- 5** Select the copy source (Settings 1 to 4). Press the [ENTER] key.
 - The copy confirmation screen is displayed.
- 6** Press the [ENTER] key.
 - The settings are copied from the copy source to "Temporary".

● To copy “Temporary” settings to Settings 1 to 4

- 1** In LOCAL mode, select [MENU] > [Setup], then press the [ENTER] key.
 - The setting types are displayed.
- 2** Select [Temporary].
 - The Setup menu is displayed.  "Setup Menu List"(P. 109)
- 3** Select [Save setting], then press the [ENTER] key.
 - The Select Save Location screen is displayed.
- 4** Select a save location (Settings 1 to 4). Press the [ENTER] key.
 - The save confirmation screen is displayed.
- 5** Press the [ENTER] key.
 - The settings are copied from “Temporary” to the save location.

Setup Menu List

The user can select to prioritize the settings on the machine or the settings on the PC. Setting individual menus to “HOST” prioritizes PC settings. To prioritize settings for this machine, select a setting other than “HOST”.

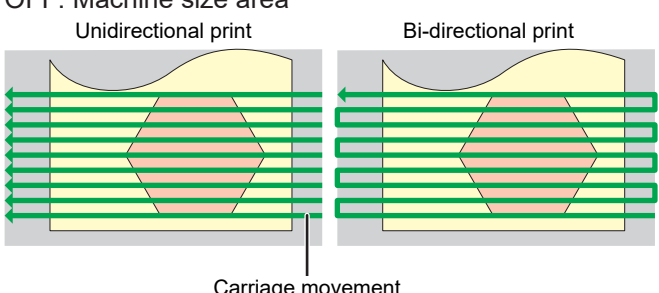

- For more information on how to specify RIP software, refer to the RIP software operating manual.

Item	Setting		Details
	*1	*2	
Feed Comp.	-9999 to <u>0</u> to 9999	-	Corrects the media feed amount. <ul style="list-style-type: none"> • Print a pattern and enter the correction amount.
Drop.PosCorrect	-40.0 to <u>0</u> to 40.0	-	Corrects the drop position for bi-directional printing. <ul style="list-style-type: none"> • Print a pattern and enter the correction amount.
Logical Seek	<u>HOST/ON/</u> OFF/Media width	OFF	Sets the range of carriage movement. <ul style="list-style-type: none"> • OFF: Machine size area <div style="text-align: center;">  <p>Carriage movement</p> </div>

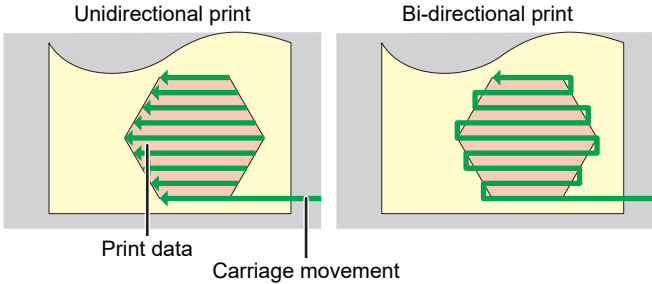
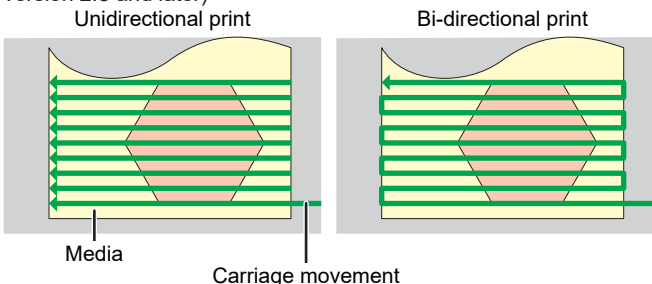
Item	Setting		Details
	*1	*2	
			<ul style="list-style-type: none"> • ON: Print data area  • Media width: Media size area (This is supported in firmware version 2.8 and later) 
OVER PRINT	<u>HOST</u> /1 to 9 times	1	Sets the number of overprinting.
DRYING TIME	-	-	Sets the ink drying time.
Scan	<u>HOST</u> /0.0 to 9.9 sec	0 sec	<p>Sets the time to stop the carriage each time the carriage scans.</p> <ul style="list-style-type: none"> • In the MIMAKI RIP software (RasterLink), it is indicated as the “drying time after each scan”.
PRINT END	<u>HOST</u> /0 to 120 min	0 min	<p>Sets the stop time after printing. After the set time passes, the next data is printed.</p> <ul style="list-style-type: none"> • The Mimaki RIP software (RasterLink) does not allow the user to specify PRINT END. If the machine is set to “HOST”, the time will be “0”.
Margin/Left	<u>HOST</u> /-10 to 85 mm	0m m	<p>Sets the offset value from the media left and right standard margins (15 mm).</p> <ul style="list-style-type: none"> • The left and right margins should be set to at least -5 mm when using the media holder. This eliminates the risk of printing on top of the media holder. • The Mimaki RIP software (RasterLink) does not allow the user to specify margins. If the machine is set to “HOST”, the offset value will be “0 mm” for the left and right margins.
Margin/Right			
Vacuum	<u>HOST</u> /Weak/ Standard/ Strong	Stro ng	<p>Sets the force with which the medium is held down.</p> <ul style="list-style-type: none"> • This can be used to prevent media jamming and print head damage caused by the media lifting up.
Feed Speed	<u>HOST</u> /10 to 100 to 200 %	100 %	<p>Sets the media feed speed.</p> <ul style="list-style-type: none"> • Depending on print conditions, the speed may not vary for certain settings. • Setting to 100 % or more reduces the time required to complete printing but may affect print quality due to insufficient drying time.

Item	Setting		Details	
	*1	*2		
Auto Cleaning	-	-	Sets the conditions to perform auto head cleaning after the preset number of files are printed.	
SETUP	File/Length/Time/OFF	-	Sets the conditions to perform auto head cleaning.	
	Interval	-	Sets auto head cleaning intervals.	
	(File)	1 to 1,000	-	Sets the interval at which the number of files is selected.
	(Length)	0.1 to 100.0 m	-	Sets the interval at which the print length is selected.
	(Time)	10 to 120 min	-	Sets the interval at which the print time is selected.
	Type	Normal/Soft/Hard	-	Sets the head cleaning type.
	Cleaning Check	ON/OFF	-	Sets whether nozzle checking is performed after auto head cleaning is completed.
Interval Wiping	3 to 255 min/OFF	-	Sets up the duration for wiping operation performed during printing. <ul style="list-style-type: none"> Use this setting if you observe any print defects (e.g., nozzle clogging, deflection) or ink droplets. 	
UV mode	ON/OFF/NoPrint	ON	Sets whether to turn on or off the UV-LED lamp. <ul style="list-style-type: none"> ON: Turns on the UV-LED lamp. OFF: Turns off the UV-LED lamp. NoPrint: Turns on the UV-LED lamp without printing. (Not used under ordinary conditions) 	
UV AdjVal	-50 to 0 to 50 %	-	You can change the preset UV lamp brightness. (This is supported in firmware version 2.8 and later.) <ul style="list-style-type: none"> Minus direction: Reduces hardness. Plus direction: Increases hardness. * Check the print results for stickiness and odor.	
MAPS4	-	-	MAPS: Mimaki Advanced Pass System <ul style="list-style-type: none"> This function disperses the boundaries between passes to make feed streaks between passes less visible. Altering MAPS may alter the color. This function may be less effective with certain types of images. 	
MAPS4	AUTO/MANUAL/OFF	-	This should normally be set to "AUTO". When set to "MANUAL", the following items are displayed:	
	Smoothing Level	0 to 100 %	-	Increasing smoothing makes streaks less visible.
	Speed	50 to 100 %	-	Reducing speed will make streaks less visible. However, printing will be slower.
	Expansion	ON/OFF	-	Selecting "ON" will make streaks less visible. However, it may increase visible grain.
Ionizer	ON/OFF	-	Sets the ionizer (optional). For more information, refer to the operating manual for the ionizer. <ul style="list-style-type: none"> Displayed when an option is connected. 	
LT mode	ON/OFF	OFF	Set if the machine needs more ink flexibility. This should be used under certain conditions.  "LT Mode"(P. 112) <ul style="list-style-type: none"> * Check the print results for stickiness and odor. 	

Item	Setting		Details
	*1	*2	
Setup Reset	-	-	Initializes the details set.

*1. The default settings are shown underlined.

*2. Settings applied if no settings can be made in the RIP software (host) or if this machine is prioritized.

LT Mode

LT mode is enabled under the following conditions:

Ink type	Ink set	Resolution	Number of passes	Media
LUS170	4-color	300 × 900	6 passes	PVC
				Tarpaulin
	600 × 600	8 passes	PVC	
			Tarpaulin	
	6-color	300 × 900	12 passes	PVC
				Tarpaulin
	600 × 600	16 passes	PVC	
			Tarpaulin	

Changing the name of a setting type

You can change the name of a setting type. The name can include alphanumeric characters or symbols.

- 1** In **LOCAL** mode, select **[MENU] > [Setup]**, then press the **[ENTER]** key.
 - The setting types are displayed.
- 2** Select **Settings 1 to 4** and press the **[FUNC2]** key.
 - The rename screen appears.
- 3** Enter the desired name, then press the **[ENTER]** key.
 - The setting type is renamed.

5.2 Maintenance Menu

This menu is used for maintenance actions. It also lets the user perform nozzle recovery if nozzle clogging persists even after cleaning and nozzle washing.

● Maintenance Menu Screen

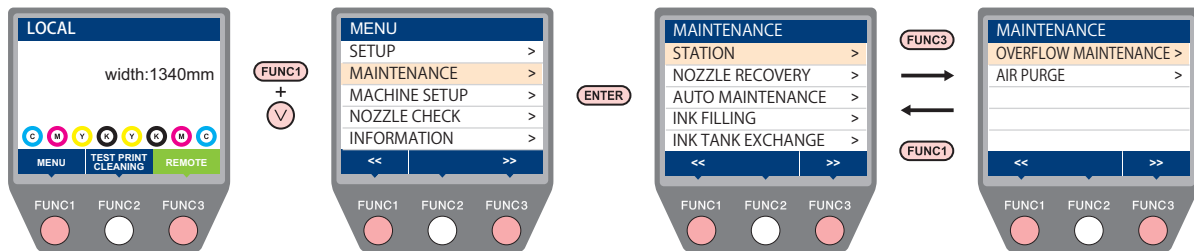



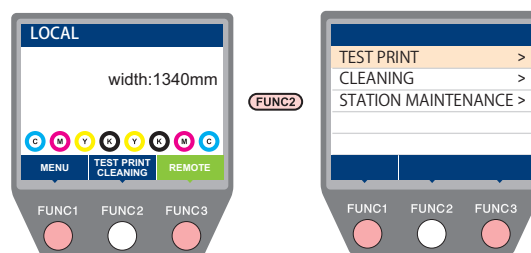

● Pressing the [TEST PRINT/CLEANING] key



Maintenance Menu List

Item	Setting *1	Details
Station	-	This moves the carriage to allow station and print head maintenance.
Carriage Out	-	
Station	-	Cleans around the station, including the cap, wiper, and NCU. "Wiper Cleaning"(P. 132) "Cap Cleaning"(P. 134) "NCU Cleaning"(P. 135)
Head Maint.	-	Cleans around the print head. "Carriage Underside Cleaning"(P. 136) "Media Sensor Cleaning"(P. 141) "Cleaning the Mist Filter"(P. 138) "Mist Filter Replacement"(P. 155)
Nozzle Wash	-	Washes the print head nozzle surface with washing liquid to resolve print defects (e.g., nozzle clogging, deflection). "Print Head Nozzle Washing"(P. 139)
Pump tube cleaning	-	Washes the suction pump tube (below the cap). "Ink Discharge Channel Cleaning"(P. 140)
Custody Wash	-	Perform this step if the machine will not be used for extended periods. The function washes nozzles and drainage channels to maintain the machine in optimal condition. "When Not in Use for Extended Periods"(P. 143)
Replace Wiper	-	Use this function when replacing the wiper. Replacing the wiper resets the wiper usage counter. "Wiper Replacement"(P. 146)

Item	Setting ^{*1}	Details	
Nozzle Recovery	-	Allows other nozzles to be used for printing if maintenance actions like nozzle washing fail to resolve print defects (e.g., nozzle clogging, deflection).	
Print	-	Prints a pattern to check nozzle condition and register the nozzle.  "Registering nozzle recovery"(P. 114)	
	-	Registers the nozzle without printing a pattern.	
	-	Initializes the details set.	
	ON/OFF	Sets whether to perform nozzle recovery before test printing. (This is supported in firmware version 2.5 and later.)	
Auto Maint.	-	Sets various maintenance actions to be performed automatically. Set the interval between individual maintenance actions. If the warning message "Replace Wasteinktank" appears, the automatic maintenance function is disabled.  "Waste Ink Tank Replacement"(P. 148) <ul style="list-style-type: none"> Beside the automatic maintenance function, the function for reapplying the negative pressure is executed during sleep. This maintains negative pressure inside the head during sleep by regularly applying negative pressure. This is executed every 15 minutes in the first one hour, and then at intervals of 30 minutes. (This is supported in firmware version 2.8 and later.)	
Refresh	0.5 to <u>4.0</u> h	Sets the refresh interval. <ul style="list-style-type: none"> Ejects a small amount of ink from the print head nozzles. This will help prevent nozzle clogging. 	
	Cleaning Interval	1 to <u>12</u> h	Sets head cleaning intervals. <ul style="list-style-type: none"> Cleans the print head. This will help prevent nozzle clogging.
	Cleaning Type	Normal/ <u>Soft</u> / Hard	Sets the cleaning type for head cleaning.
FILL UP INK	-	Fills the ink to resolve printing defects (e.g., nozzle clogging, deflection).	
Replace Waste ink tank	-	Resets or corrects the waste ink tank usage count.  "Waste Ink Tank Replacement"(P. 148)	
Overflow	-	Performed when the "ink overflow" error is displayed. <ul style="list-style-type: none"> Drains excess ink from the sub tank to resolve ink overflows. If the error is not cleared, execute this operation repeatedly. If it persists even after three attempts, contact your local dealer or our service office. 	
Air purge	-	Use this if ink colors are mixed or if the mixed air causes nozzle clogging. Purge ink and air inside the print head from the port in front of the carriage.  "Ink colors are mixed."(P. 163)	

*1. The default settings are shown underlined.

Registering nozzle recovery

Allows other nozzles to be used for printing if maintenance actions like nozzle washing fail to resolve print defects (e.g., nozzle clogging, deflection).



- Nozzle recovery can be specified for up to ten nozzles per row.
- The time taken for printing remains unchanged even when nozzle recovery is set.



- Load media at least 500 mm wide. You cannot print the entire pattern if media less than 500 mm wide is used.

- 1 Load the media.**
- 2 In LOCAL mode screen, select [MENU] > [Maintenance], then press the [ENTER] key.**
 - The Maintenance menu is displayed.
- 3 Select [Nozzle Recovery] > [Print], then press the [ENTER] key.**
 - Print a nozzle recovery pattern.
 - The Select Entry Nozzle screen appears once printing is complete.

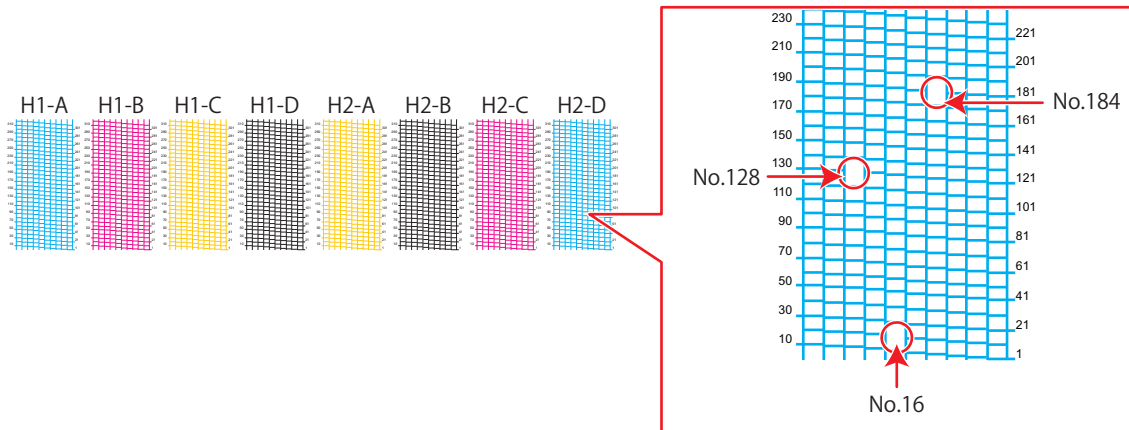

- For 6-color ink sets, “H1-B” and “H1-D” are not printed.

- 4 Select the “head number and nozzle row” for nozzle recovery, then press the [ENTER] key.**

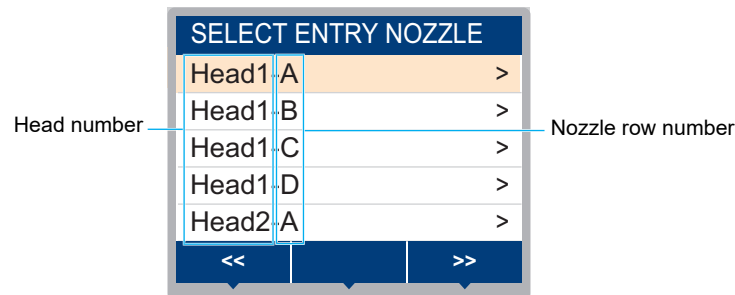

- 5 Enter the “nozzle number” for nozzle recovery, then press the [ENTER] key.**

- Select the entry number before entering the nozzle number.
- Nozzle recovery is set.

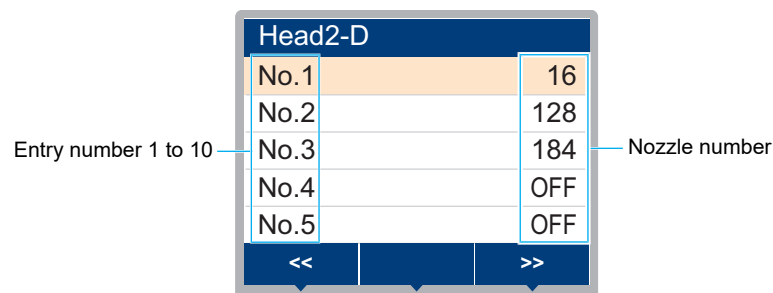

6 Press the [ENTER] key once entry is complete.



- Select [Maintenance] > [Nozzle Recovery] > [Test Print], then select "ON" to perform nozzle recovery and test printing. (This is supported in firmware version 2.5 and later.)
 ["Test Printing"\(P. 67\)](#)
-

5.3 Machine Setup Menu

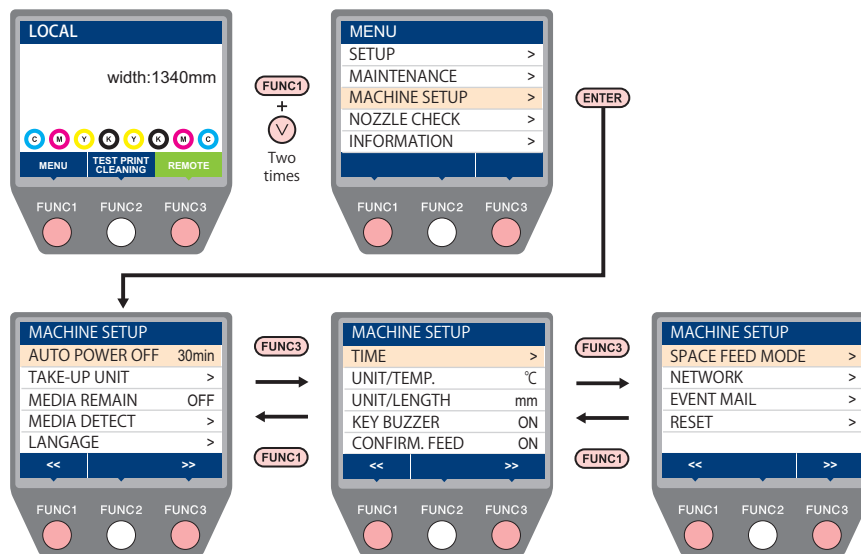

This is used to set various operations to ensure optimal machine performance.

● Machine Setup Menu Screen



Machine Setup Menu List

Item	Setting ^{*1}	Details
Auto Power-off	None/10 min to <u>30 min</u> to 600 min	Sets the time until the power is automatically turned off.
Take-up Unit	-	Sets the take-up unit operation.
Take-up Unit	<u>ON/OFF</u>	Set to "OFF" if the take-up unit is not used.
Take-up SW	<u>Continuous/Temporary</u>	Sets the function performed by the ON/OFF button on the take-up unit in LOCAL mode. <ul style="list-style-type: none"> Continuous: Press the button to start/stop the take-up unit. Temporary: The take-up unit operates only while the button is pressed. The unit stops when the button is released.
Media Remain	<u>ON/OFF</u>	The remaining roll media amount can be displayed and printed out in REMOTE mode. The print length will be displayed when leaf media is in use. <ul style="list-style-type: none"> ON: An input screen appears once the media width is detected. <ul style="list-style-type: none"> ▲ Press ▼ to set the media length. Press the [FUNC3] key on the "Origin Setup" screen to print the date and remaining media amount. OFF: The remaining media amount is not displayed.
Media Detect	-	Sets the media width detection method.
DETECTION TYPE	<u>AUTO/MANUAL</u>	<ul style="list-style-type: none"> AUTO: The media width is automatically detected with the sensor. MANUAL: ▲ Press ▼ to set the media width manually. When using a media that cannot be detected by the sensor, such as black cutting sheets, set to "MANUAL".
Use PR Number Query	<u>ON/OFF</u>	Sets whether to display the screen for entering the number of pinch rollers to be used after media width detection.

Item	Setting ^{*1}	Details
		<ul style="list-style-type: none"> • ON: Displays the input screen. • OFF: The “host” takes priority. Set this to "OFF" when configuring pinch roller pressure settings on this machine.  "Setting the Pressure and Number of Pinch Rollers to Use"(P. 66)
LANGUAGE	<u>English</u> /日本語/中文/Turkce	Sets the display language.
Time Set	+4 h to <u>0</u> to -20 h	Sets the current time and date. (With respect to JST) <ul style="list-style-type: none"> • This can be set within the range of -20 to +4 hours.
UNIT / TEMP	<u>°C</u> /°F	Sets the display unit for temperature (Celsius/Fahrenheit).
UNIT / LENGTH	<u>mm</u> /inch	Sets the display units for length and area. <ul style="list-style-type: none"> • Some items are displayed in “mm” even if “inches” is selected.
Key Buzzer	<u>ON</u> /OFF	Sets an audible tone when keys are pressed. <ul style="list-style-type: none"> • Audible signals indicating errors, warnings, and operation end cannot be muted, even if “OFF” is selected for this setting.
View Feed	<u>ON</u> /OFF	Sets whether or not to feed the media forward to view the print results—for example, during test printing.
Space Feed Mode	<u>Intermittent</u> /Continuous	Alters the feed method for blank space included in the image data. <ul style="list-style-type: none"> • Intermittent: Uses intermittent feeding based on the timing of a fraction of the pass. • Continuous: Feeds forward by skipping blank parts.
Network	-	Sets the network address. The machine must be restarted to enable this setting.
Check IP Address	-	Displays the machine’s current IP address. <ul style="list-style-type: none"> • It may take some time to determine the IP address. If the IP address cannot be determined, the display will indicate “0.0.0.0”.
Check MAC Address	-	Displays the machine’s current MAC address.
DHCP	<u>ON</u> /OFF	Select “ON” to use the IP address assigned by the DHCP server.
AutoIP	<u>ON</u> /OFF	Select “ON” to use the IP address set by the AutoIP protocol. Note that DHCP takes priority if DHCP is set to “ON”.
IP Address	-	Sets the machine’s IP address. <ul style="list-style-type: none"> • This can be set when both [DHCP] and [AutoIP] are set to “OFF”.
Default Gateway	-	Sets the machine’s default gateway. <ul style="list-style-type: none"> • This can be set when both [DHCP] and [AutoIP] are set to “OFF”.
DNS Address	-	Sets the machine’s DNS server address. <ul style="list-style-type: none"> • This can be set when both [DHCP] and [AutoIP] are set to “OFF”.
Sub Net Mask	-	Sets the number of subnet mask digits used by this machine. <ul style="list-style-type: none"> • This can be set when both [DHCP] and [AutoIP] are set to “OFF”.
Event Mail	-	An email can be sent to a specified email address when an event (e.g., print start, print end, and abort) occurs. The machine must be restarted to enable this setting.  "Event Email Function Settings"(P. 120)
Mail Delivery	<u>ON</u> /OFF	Sets whether event emails are sent.
Select Event	-	

Item	Setting ^{*1}	Details
Print Start Event	<u>ON/OFF</u>	Sets whether an email is sent when printing starts.
Print End Event	<u>ON/OFF</u>	Sets whether an email is sent when printing ends.
Plot Start Event	<u>ON/OFF</u>	Sets whether an email is sent when cutting starts.
Plot End Event	<u>ON/OFF</u>	Sets whether an email is sent when cutting ends.
Error	<u>ON/OFF</u>	Sets whether an email is sent when an error occurs.
Warning	<u>ON/OFF</u>	Sets whether an email is sent when a warning occurs.
Other Event	<u>ON/OFF</u>	Set to send or not send an email when an event other than those listed above occurs.
Mail Address	-	Sets the email address to which emails will be sent (not to exceed 96 alphanumeric characters or symbols).
Message Subject	-	Sets the characters contained in a message subject (not to exceed 8 alphanumeric characters or symbols).
Server Setup	-	
SMTP Address	-	Sets the SMTP server.
SMTP Port No.	-	Sets the SMTP port number.
Sender Address	-	Sets the sender address (not to exceed 64 alphanumeric characters or symbols). <ul style="list-style-type: none"> Setting an email address corresponding to the server account allows emails to be sent.
Authentication	<u>OFF/POP before SMTP/SMTP authentication</u>	Sets the SMTP server authentication method.
User Name	-	Sets the user name used for authentication (not to exceed 30 alphanumeric characters or symbols). <ul style="list-style-type: none"> This can be set when [Authentication] is not set to "OFF".
Pass Word	-	Sets the password used for authentication (not to exceed 15 alphanumeric characters or symbols). <ul style="list-style-type: none"> This can be set when [Authentication] is not set to "OFF".
POP3 Address	-	Sets the POP server. <ul style="list-style-type: none"> This can be set when [Authentication] is set to "POP before SMTP".
APOP	-	Enables or disables APOP. <ul style="list-style-type: none"> This can be set when [Authentication] is set to "POP before SMTP".
Transmit Test	-	Sends a test email. --- リンクがありません ---
Reset	-	Initializes the details set.

*1. The default settings are shown underlined.

Event Email Function Settings

An email can be sent to a specified email address when an event (e.g., print start, print end, and abort) occurs.



- SSL (Secure Socket Layer) encoding is not supported.



- Connect the LAN cable to use the event mail function.
 ["Network Connection Precautions"\(P. 35\)](#)

Disclaimers

- Internet communication charges for email notifications, etc. are the responsibility of the customer.
- Event emails may not be delivered if problems arise with the Internet setup or equipment. Mimaki rejects all liability for damages resulting from delivery failure or delay.

Sending Test Email

- 1 In LOCAL mode, select [MENU] > [Setup], then press the [ENTER] key.**
 - The Machine Setup menu is displayed.
- 2 Select [Event Mail] > [Transmit Test], then press the [ENTER] key.**
- 3 Press the [ENTER] key.**
 - The transmission results are displayed.
 - An error code will be displayed if the test email transmission is unsuccessful. Refer to the error code list and take appropriate action.

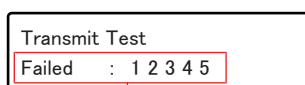

Error code



- Emails may not necessarily be delivered even if they have been sent. Check the terminal receiving the email for spam email filters.
- For more information on server settings or other topics, contact your network administrator or service provider.

- 4 Press the [ENTER] key once the test is complete.**

● Error Code List

Error code	Likely cause	Corrective action
10	Network connection error	<ul style="list-style-type: none"> • Check to confirm that this machine is connected to a network. • Check the IP address for this machine. • Check if the network setup allows this machine to use DNS.
20	No valid email address	<ul style="list-style-type: none"> • Enter a valid email address.
11003 11004	No POP server was found or the DNS server could not be accessed.	<ul style="list-style-type: none"> • Check the POP server address. • Check if the network setup allows this machine to use DNS.
11021	Unable to connect to POP server	<ul style="list-style-type: none"> • Check the POP server settings. • Check the firewall settings.

Error code	Likely cause	Corrective action
12010	An error was returned from the POP server.	<ul style="list-style-type: none"> • Check the POP server settings.
13000	POP authentication failed	<ul style="list-style-type: none"> • Check the user name and password. • Check the APOP settings. • Check the authentication method.
10013 10014	No SMTP server could be found or the DNS server could not be accessed.	<ul style="list-style-type: none"> • Check the SMTP server address. • Check if the network setup allows this machine to use DNS.
10021	Unable to connect to SMTP server	<ul style="list-style-type: none"> • Check the SMTP server settings. • Check the SMTP port number. • Check the firewall settings.
10*** 11*** 20*** 21***	An error was returned from the SMTP server or there was no response.	<ul style="list-style-type: none"> • Check the SMTP server settings. • Communication is not possible with a server that requires SSL communication. • Check the protocol filter settings.
12***	The sender email address is invalid.	<ul style="list-style-type: none"> • Set an email address corresponding to the server account.
13***	The email recipient could be found or the email address is invalid.	<ul style="list-style-type: none"> • Check the email address. • This error may not always be detected even if the email address is incorrect. • Set an email address corresponding to the server account.
22000 22008	SMTP authentication error	<ul style="list-style-type: none"> • Check the authentication method.
23*** 24*** 25***	SMTP authentication failed.	<ul style="list-style-type: none"> • Check the user name and password.

1. *** is the error code received from the mail server



- If the error persists, wait a while before retrying.

5.4 Nozzle Check Menu

This is used to check if the nozzles are clogged before printing starts. Sets whether to perform maintenance automatically if nozzle clogging is detected.

● Nozzle Check Menu Screen

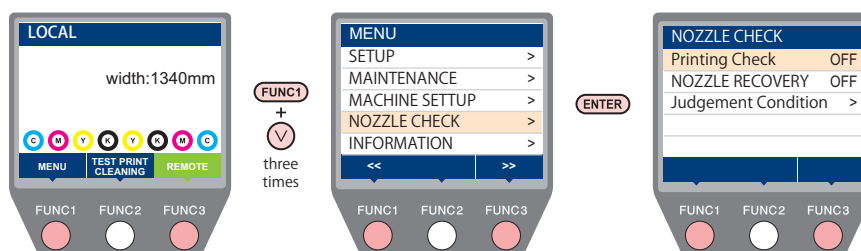

Nozzle Check Menu List

Item	Setting ^{*1}	Details
Printing Check	<u>ON/OFF</u>	Performs nozzle clogging detection before printing starts.
<ul style="list-style-type: none"> Check Interval <ul style="list-style-type: none"> Length File Action <ul style="list-style-type: none"> Cleaning Retry Count 	-	Sets the nozzle clogging detection timing.
	0.1 m to <u>30.0</u> m to 50.0 m	Performs nozzle clogging detection after the length set is reached and before the next print starts.
	1 to <u>30</u> to 100 files	Performs nozzle clogging detection for each number of files set.
	-	Performs nozzle recovery (cleaning followed by nozzle checking) if "nozzle clogging" is detected.
	<u>Soft</u> /Normal/ Hard	Sets the cleaning type.
	<u>0</u> to 3 times	Performs nozzle recovery (cleaning followed by nozzle checking) for the specified number of times.
Auto Nozzle Recovery	<u>ON/OFF</u>	Performs nozzle recovery automatically if "nozzle clogging" is detected. See below if you wish to perform nozzle recovery manually. "Registering nozzle recovery"(P. 114)
Judgment Condition ^{*2}	<u>1</u> to 64 nozzles	Set the number of nozzles to be detected as clogged before "nozzle clogging" is detected. Up to 16 nozzles per row can be set. The next print will not start if "nozzle clogging" is detected during continuous printing.

*1. The default settings are shown underlined.

*2. Nozzle recovery is not available for certain print conditions.



- If an error occurs during the nozzle check operation, the next print will be automatically stopped, and [Printing Check] will be set to "OFF". Clear the error, then set [Printing Check] to "ON" manually.

5.5 Information Menu

This is used to check machine information.

● Information Menu Screen

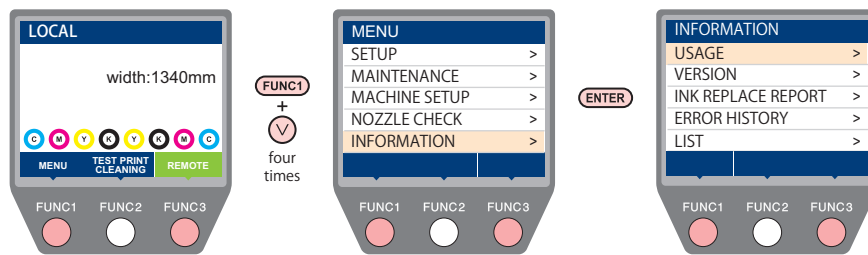

Information Menu List

Item		Details
Usage	Wiping	Displays the wiping count. <ul style="list-style-type: none"> To reset this count, press the [FUNC2] key while the count is displayed.
	Waste ink tank	Displays the approximate level of waste ink in the waste ink tank as a percentage. <ul style="list-style-type: none"> To reset waste ink levels, press the [FUNC1] key while the level is displayed.
	Print Length	Displays the total length printed.
	Print Area	Displays the total area printed.
	Use Time	Displays the total time the power has been turned on.
	UV Lamp	Displays the total time the UV lamp has been used.
Version		Displays the machine firmware and other versions.
Ink REPL.Report		Prints the ink history.
Error History		Displays the error and warning history. <ul style="list-style-type: none"> These are listed in chronological order. Use the keys to cycle through occurrence time/date and error/warning information.
List		This is used to print machine information.

5.6 Cutting Menu

You can set various settings related to cutting functions.

● Cutting Menu Screen

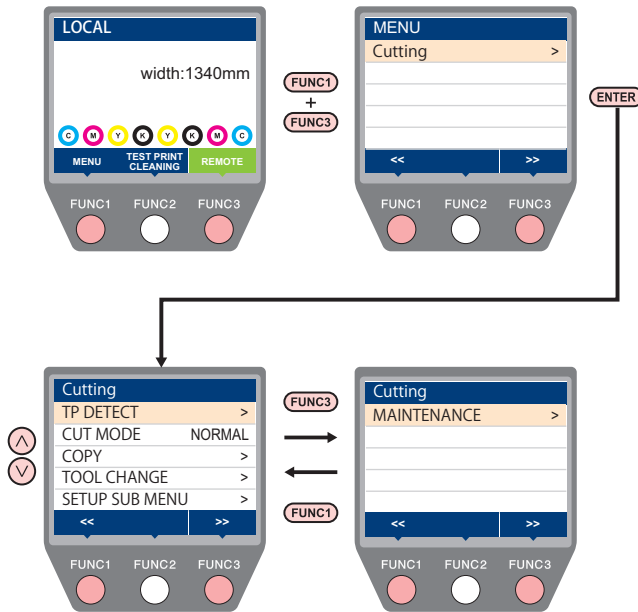

Cutting Menu List

Item	Setting *1	Details
TP DETECT	-	Enter the conditions of the printed register marks.
Detection	ON/OFF	Set this to ON to cut cutting data with register marks.
Shape	Type 1/Type 2/Zero Margin	Select three types of register mark shapes. "Register marks"(P. 98)
Size	5 to 40 mm	Set the register mark length (B). "Standards for Register Mark Length and Line Width"(P. 99)
OFFSET X	-5.00 to 5.00 mm	Change the position of the register mark origin. If the cut position shifts in the same direction, change the position of the origin.
OFFSET Y	-5.00 to 5.00 mm	<ul style="list-style-type: none"> • If "ERROR 37 MARK ORG" is displayed, change the layout by referring to the following. "Reading Range of Register Marks"(P. 100)

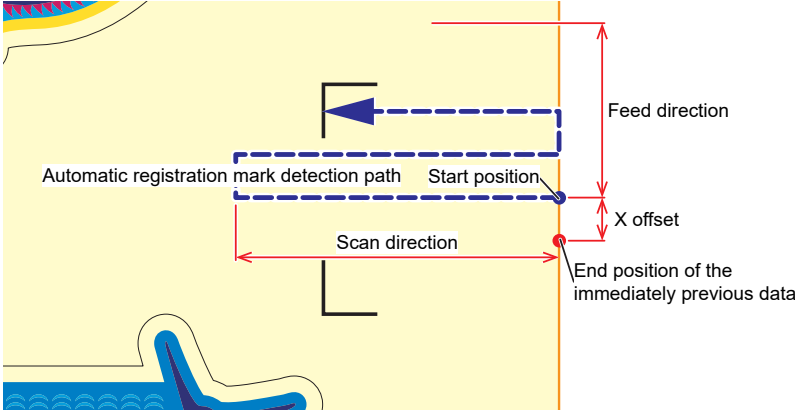
Item	Setting ^{*1}	Details
DETECT END KEY START	ON/OFF	If you press the [END] key in LOCAL mode, the cutter unit moves over the platen so that register marks can be detected.
SENSOR LEVEL	1 to 7	Check the sensitivity of the register mark sensor. Normally, set this to "4". <ul style="list-style-type: none"> If it cannot detect the register marks: Increase sensitivity. If it mis-detects the register marks: Decrease sensitivity.
MARK FILLUP	ON/OFF	When the "Fill around the register mark" function of the RIP software is enabled, set this to "ON".
DETECT AREA	-	Sets the automatic register mark detection area. 
Scan Dir.	DEFAULT/0 cm to machine width	Sets the scan direction for automatic register mark detection. <ul style="list-style-type: none"> When set to [DEFAULT], the detection operation is performed at half the media width.
Feed Dir.	10 to 50 cm	Sets the media feed direction for automatic register mark detection.
OFFSET X	0 to 100 cm	Sets the automatic detection start position for the next register mark.
CUT MODE	Standard/High Speed/High Quality	Sets the cutting quality. <ul style="list-style-type: none"> Standard: Normally, use this setting. High Speed: This cuts media in a short period of time. This is not suitable for use with heavy media. High Quality: This puts priority on the cutting quality, and limits the cutting speed to 20 cm/s. Select "High Quality" when cutting the following data. <ul style="list-style-type: none"> Data containing 10 mm characters or smaller Data containing many sharp edges Fine cutting data Cut lines may be jagged depending on the data. In this case, change the setting to "High Speed" to make cut lines smooth.
COPY	-	Cut the data stored in the receive buffer of the machine by the specified number. ☞ "Copying the last data"(P. 127)
COPIES	1 to 999	Enter the number of copies.
Interval	0 to 30 mm	Select the cut data interval.
TOOL CHANGE	-	Select this when replacing tools. ☞ "Installing Cutting Tools"(P. 82)
SETUP SUB MENU	-	
UP SPEED	-	

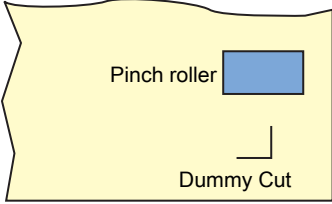
Item		Setting ^{*1}	Details
	UP SPEED X	<u>AUTO</u> /5 to 30 cm/s	Set the movement speed of the media and carriage while the tool is up. Setting a slower speed can reduce media offsets in the feed direction.
	UP SPEED Y	<u>AUTO</u> /5 to 30	Set the movement speed of the media and carriage while the tool is up.
	DUMMY CUT	<u>ON</u> /OFF	Cuts the media to make the cutting blade face a certain direction after media detection or tool changes. (Performs a dummy cut in front of the pinch rollers which are closest to both ends of the cutter unit.)  If you wish to avoid damage to the media or cut cut-out characters, set this to OFF. Perform test cutting to adjust the direction of the cutting blade. ☞ "Test Cutting"(P. 91) If the tool condition is set to "PEN", dummy cutting is disabled.
	SHEET TYPE	<u>Normal</u> /Heavy	Set the weight of the set media.
	ADJ-PRS OFFSET	-9 to <u>0</u> to 9	When cutting the corners, the pressure is automatically decreased (by about 5 g) to prevent the media from lifting up. As a result, the cutting blade might not rotate smoothly and may leave uncut parts. Adjust the pressure for cutting the corners if they are left uncut.
	Vacuum	<u>Weak</u> / Standard/ Strong/OFF	Sets the force with which the medium is held down during cutting. Ordinarily, use "Weak".
	OVER CUT	<u>OFF</u> /0.1 to 1.0 mm	Overlaps the start and end points so that no part of the media is left uncut. ☞ "Preventing uncut media"(P. 127)
	CORNER CUT	<u>ON</u> /OFF	Performs over cutting at corners other than the start and end point. ☞ "Preventing uncut media"(P. 127)
	CURVE MODE	<u>FAST</u> /SLOW	If the cut line gets twisted, set this to "SLOW". This can prevent twisting but decreases cutting speed.
	Setup Reset	-	Initializes the details set.
Maintenance		-	
	MARKS SENSOR	-	
	SENSOR CHK	-	Check the responsiveness of the register mark sensor. ☞ "Adjusting the Position of the Register Mark Sensor"(P. 168)
	POINTER OFFSET	-	Adjust the position of the light pointer when the positions of the register mark sensor and light pointer do not match. ☞ "Correcting the LED Pointer Position"(P. 169)
	SAMPLE CUT	-	The machine cuts a sample stored in the unit to troubleshoot problems when data cannot be cut properly. ☞ "Investigating the Cause of Cutting Failures"(P. 170)

Item	Setting ^{*1}	Details
AUTO MEDIA CUT	-	Cuts the media into several pieces of fixed length.
CUT INTERVAL	10 to 10,000 mm	Sets the cut length.
FRONT CUT OFF	0 to 500 mm	The front edge of the media can be cut off if cut diagonally. Sets the cut length.
COUNT	1 to 9,999 times	Sets the number of media pieces to be cut.
SCALE ADJUST	-	
Y600dpi	-	When printing and cutting without register marks, perform corrections when the media deviates to the left or right side of the scan direction.
Y1200dpi	-	

*1. The default settings are shown underlined.

Copying the last data

You can cut the data stored in the receive buffer of the machine by the specified number (up to 999 sheets).

- The last cutting data is stored in the receive buffer. When new data is received, the already saved data is overwritten.
- Reset the origin before executing the copy function. Failure to do so will result in overlap cutting.

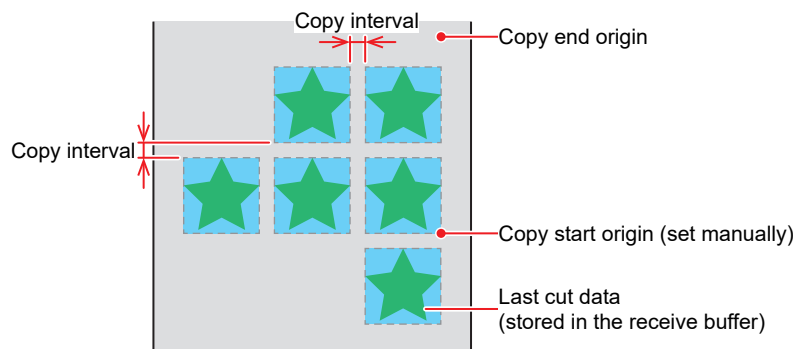

- The machine cuts the specified number of sheets of the divided cut data without separating the data.



- When using the MIMAKI cutting software “FineCut”, deselect the “Sheet Feed Origin Renewal” checkbox. (This is unselected by default.) Selecting the checkbox results in overlap cutting.
- When sending the cut data from the PC, wait for at least 5 seconds before sending the next data. If the next data is sent within five seconds, both pieces of data may be copied.

Preventing uncut media

Overlapping the start and end points can prevent the media from being left uncut. Configure this setting for very flexible media. Setting too large a value will result in cut prints. Perform test cutting and adjust accordingly.

● OVER CUT

The machine cuts the media in front of the cutting start point by the set value. The media is overcut by the set value at the end point.

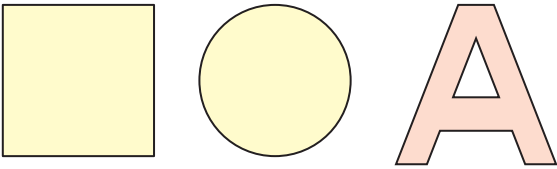
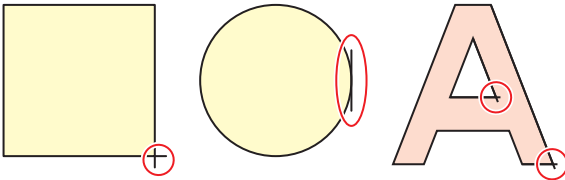
OVER CUT: OFF	OVER CUT: 0.1 to 1.0 mm
	

● **CORNER CUT**

When the OVER CUT setting value is entered, CORNER CUT is displayed. The machine performs over cutting at corners other than the start and end point.

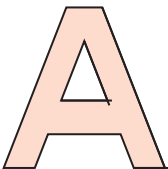
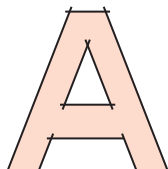
CORNER CUT: OFF	CORNER CUT: ON
	

Chapter 6 Maintenance



This chapter

To ensure years of precise performance, maintain this product periodically or based on frequency of use.

Read the maintenance precautions thoroughly before maintaining this product.

Maintenance Precautions	130	Consumable Item Replacement	146
Daily Maintenance	131	Wiper Replacement	146
Maintenance Items and Timing	131	Cap Absorber Replacement.....	147
Items Required for Maintenance	131	Waste Ink Tank Replacement.....	148
Ink Maintenance.....	132	Exhaust Fan Filter Replacement.....	151
Wiper Cleaning.....	132	Pinch Roller Replacement	152
Cap Cleaning	134	Media Holder Replacement	153
NCU Cleaning	135	Media Cutter Replacement	154
Carriage Underside Cleaning.....	136	Mist Filter Replacement	155
Cleaning the Mist Filter	138	LED Glass Replacement.....	156
Print Head Nozzle Washing	139	Consumable Item Replacement (Cutting	
Ink Discharge Channel Cleaning.....	140	Related).....	158
Media Sensor Cleaning.....	141	Pen Line Replacement.....	158
Media Holder Cleaning.....	142		
Platen Cleaning.....	142		
Cover (Exterior) Cleaning.....	143		
When Not in Use for Extended Periods ...	143		

6.1 Maintenance Precautions



- This product contains components that must be replaced periodically. We recommend concluding a maintenance contract.
- Maintain this product and replace consumable items to prevent quality defects and accidents.

⚠ WARNING



- Clean periodically. Debris and dust will accumulate on electrical components when this product is used for extended periods. Current leaks may result in failure, electric shock, or fire.
- Do not clean by blowing—e.g., avoid using air blowers. Doing so may lead to failure, electric shock, or fire involving the product if airborne debris or dust gets inside electrical components. Wipe away debris or dust using a soft cloth soaked in water and thoroughly wrung out. A vacuum cleaner may also be used for cleaning.



- Do not allow liquids to get inside the product. Ingress of liquids into the product may lead to failure, electric shock, or fire.

⚠ CAUTION



- For heavy soiling, wipe using a soft cloth soaked in dilute detergent and thoroughly wrung out.



- Wear safety glasses, gloves, and a mask when handling ink, maintenance cleaning solution, waste ink, or other solutions used with this machine. Leaking ink may adhere to the skin or get into your eyes or mouth.



NOTICE



- Avoid touching the print nozzle surface. Do not allow water or alcohol to come into contact with the print nozzle surface. Contact with water or alcohol may lead to failure or print defects (e.g., nozzle clogging, deflection).
- Avoid using cotton swabs to clean around the head or carriage. Fibers from cotton swabs may adhere to the head nozzle surface and lead to print defects (e.g., nozzle clogging, deflection).
- Be careful to avoid splashing ink or washing liquid on the covers. Exposure to splashing ink or washing liquid may damage or deform the cover.
- Avoid using chemical products containing benzene, thinner, or abrasives. Use of these chemicals may result in damage to or deformation of parts.
- Do not move the carriage by hand. To move the carriage, use the carriage out function on the menu.

6.2 Daily Maintenance

Maintenance Items and Timing

Timing	Item
At the end of the work day	Clean the wiper and wiper bracket. "Wiper Cleaning"(P. 132)
	Clean the wiper cleaner. "Wiper Cleaning"(P. 132)
	Clean the cap rubber. "Cap Cleaning"(P. 134)
	Clean the NCU. "NCU Cleaning"(P. 135)
	Clean the underside of the UV-LED lamp. "Carriage Underside Cleaning"(P. 136)
	Clean the underside of the carriage. "Carriage Underside Cleaning"(P. 136)
	Mist filter 1 Soak up ink with a paper towel. "Cleaning the Mist Filter"(P. 138)
	Clean the media sensor. "Media Sensor Cleaning"(P. 141)
Clean the media holder. "Media Holder Cleaning"(P. 142)	
At the end of the work week	Ink pad in the waste ink holder under the wiper Soak up ink with a paper towel. "Wiper Cleaning"(P. 132)
	Mist filter 2 Soak up ink with a paper towel. "Cleaning the Mist Filter"(P. 138)
	Clean the ink discharge channel. "Ink Discharge Channel Cleaning"(P. 140)
	Clean the platen. "Platen Cleaning"(P. 142)
	Clean the cover (exterior). "Cover (Exterior) Cleaning"(P. 143)
	Check the waste ink levels in the waste ink tank.
When noticeably dirty	Replace with new exhaust fan filter. "Exhaust Fan Filter Replacement"(P. 151)
	Replace the exhaust fan BOX.
When not used for more than a week	Clean the wiper and cap and wash the ink discharge channels. After cleaning, store without turning off the main power supply. "When Not in Use for Extended Periods"(P. 143)
Periodically	Shake the Ink bottle. "Ink Maintenance"(P. 132)

Items Required for Maintenance

To order replacement consumable items, contact your local dealer or our service office.

Item	Code
F-200/LF-200 Washing Liquid Kit	SPC-0569
F-200/LF-200 Washing Liquid	SPC-0568
UJ Cleaning Swab	SPC-0386
Cleaning Stick for Head Surrounding	SPC-0527
Nozzle Swab	SPC-0421
Swab 6-axis "S"	A101438

Item	Code
Paper towel (KIM TOWEL)	SPC-0499
KIMWIPE S-200	SPA-0207
Maintenance cloth	SPC-0574
UV goggles	SPC-0387
Safety glasses	
Gloves	

For more information on other consumable items, refer to our website.

<https://mimaki.com/supply/inkjet.html>



- Do not store in places accessible to children.

Ink Maintenance

If ink constituents are sedimented, the ink density may become uneven. We recommend shaking the Ink bottle periodically to keep printing consistent.

UV ink: once a month.

● Shaking the Ink bottle

1 Shake the Ink bottle to the left and right slowly at least 20 times.

- Tighten the ink bottle lid securely, then shake the bottle slowly from left to right to ensure that the ink moves inside, holding the ink bottle lid with a paper towel.

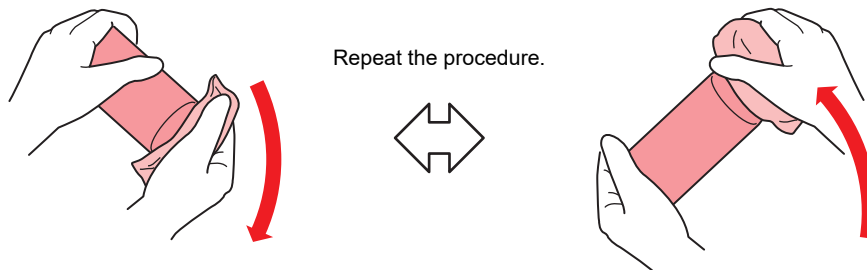

- Shake slowly. If the bottle is shaken too violently, ink may leak out or the air mixed in the ink may cause nozzle clogging.
- If the Ink bottle is partially used, flip the Ink bottle upright and shake slowly at an angle.

Wiper Cleaning

The wiper wipes off ink adhering to the print head nozzle surface. Continuing to use the dirty wiper may cause the wiper to which dried ink and dust are attached to rub against the nozzle surface, leading to print defects (e.g., nozzle clogging, deflection).



- Be careful to avoid leaving fragments from the cleaning stick behind when cleaning. These fragments will increase the risk of print defects (e.g., nozzle clogging, deflection).

1 In LOCAL mode screen, select [MENU] > [Maintenance], then press the [ENTER] key.

- The Maintenance menu is displayed.

2 Select [Station] > [Carriage Out] > [Station Maint.], then press the [ENTER] key.

- The carriage moves over the platen.

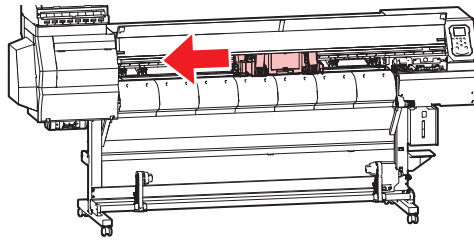

3 Open the front cover.

4 Pull out the wiper.

- Pull out the wiper by holding the protrusions at both ends.

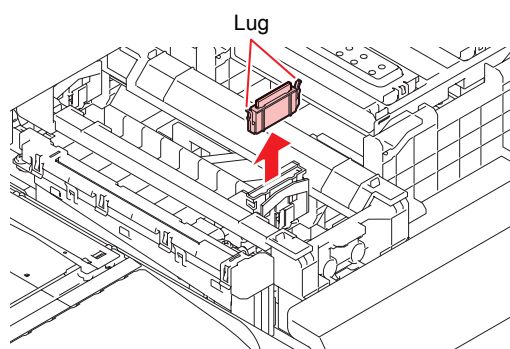

5 Clean the wiper and bracket.

- Wipe off any ink adhering to the wiper and bracket using a cleaning stick moistened with washing liquid.
- Wipe off the washing liquid. Make sure none remains.

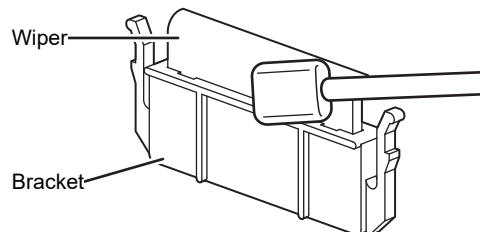

- Replace dirty or warped wipers with new ones.
☞ "Wiper Replacement"(P. 146)

6 Reattach the wiper at the original position.

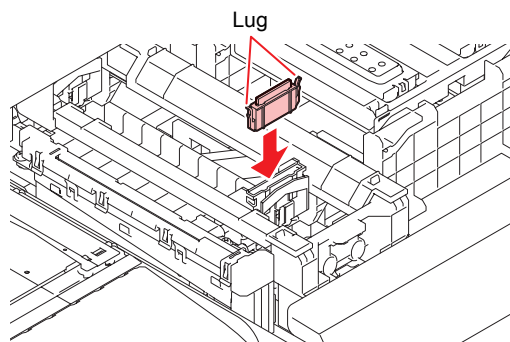

7 Clean the wiper cleaner.

- Wipe off any ink adhering to the wiper cleaner using a cleaning stick moistened with washing liquid.
- Wipe off the washing liquid. Make sure none remains.

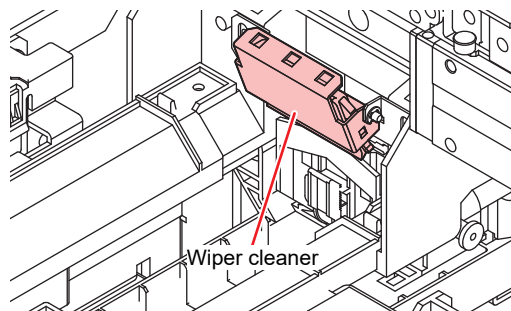

- Only clean the front side of the wiper cleaner. There is no need to clean the backside.



- Do not remove the wiper cleaner from the bracket.



- After cleaning is completed, check to confirm that the wiper cleaner is not facing up.

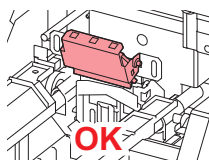

- Soak up ink in the waste ink holder with a paper towel once a week. Doing so may result in leaking ink.

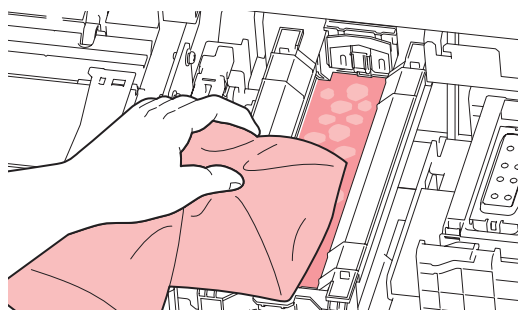

- Do not remove the absorbent material in the absorbent material case. Doing so may result in leaking ink.

8 Press the [ENTER] key once cleaning is complete.

9 Close the front cover, then press the [ENTER] key.

Cap Cleaning

The cap prevents the print head nozzle surface from drying out. Continuing to use a dirty cap may affect ink take-up and lead to print defects (e.g., nozzle clogging, deflection).



- Be careful to avoid leaving fragments from the cleaning stick behind when cleaning. These fragments will increase the risk of print defects (e.g., nozzle clogging, deflection).

- 1** In LOCAL mode screen, select [MENU] > [Maintenance], then press the [ENTER] key.
 - The Maintenance menu is displayed.
- 2** Select [Station] > [Carriage Out] > [Station Maint.], then press the [ENTER] key.
 - The carriage moves over the platen.

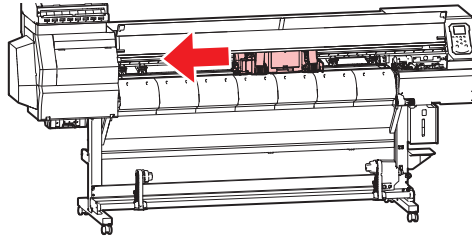

- 3** Open the front cover.
- 4** Clean the cap rubber.

- Wipe off any ink adhering to the cap rubber using a cleaning stick moistened with washing liquid.
- Wipe off the washing liquid. Make sure none remains.

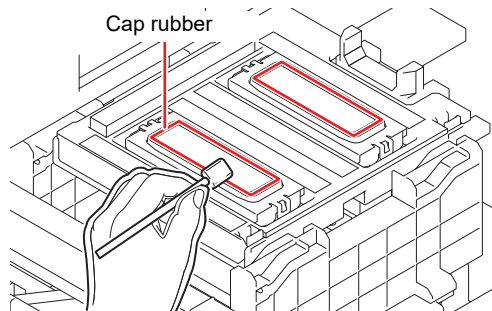

- 5** Check to confirm that the cap slider is not tilted once cleaning is complete.



- If the cap slider is tilted, move the slider block to the left or right to correct the tilt.

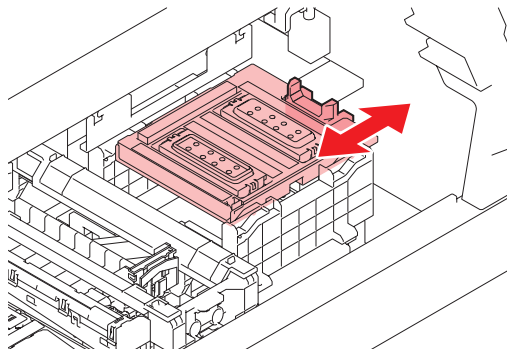

- 6** Press the [ENTER] key once cleaning is complete.
- 7** Close the front cover, then press the [ENTER] key.

NCU Cleaning

The NCU uses a sensor to monitor the ink droplets ejected from the print head nozzles. Continuing to use the dirty NCU may prevent the nozzle recovery function from operating correctly.



- Be careful to avoid leaving fragments from the cleaning stick behind when cleaning. These fragments will increase the risk of print defects (e.g., nozzle clogging, deflection).

1 In **LOCAL** mode screen, select **[MENU] > [Maintenance]**, then press the **[ENTER]** key.

- The Maintenance menu is displayed.

2 Select **[Station] > [Carriage Out] > [Station Maint.]**, then press the **[ENTER]** key.

- The carriage moves over the platen.

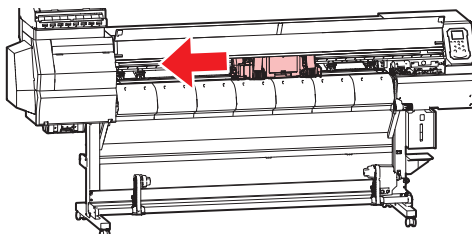

3 Open the front cover.

4 Wipe away any ink or dust adhering to the NCU.

- Wipe off any ink adhering to the NCU using a cleaning stick moistened with washing liquid.
- Wipe off the washing liquid. Make sure none remains.

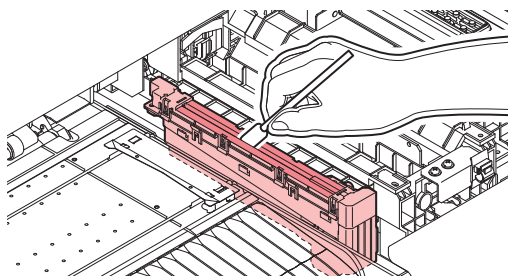

- Insert the cleaning stick as far as the line shown in the figure.

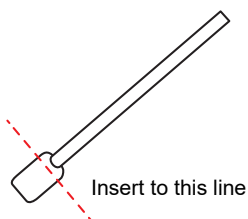

5 Press the **[ENTER]** key once cleaning is complete.

6 Close the front cover, then press the **[ENTER]** key.

Carriage Underside Cleaning

The underside of the carriage becomes coated with ink wiped off by the wiper. Continuing to use the dirty carriage underside will rub dried ink and attached dust on to the media, resulting in contaminated prints.

The print head uses an extremely delicate mechanism. Take great care when handling it.



- Be careful to avoid leaving fragments from the cleaning stick behind when cleaning. These fragments will increase the risk of print defects (e.g., nozzle clogging, deflection).

- 1** In LOCAL mode screen, select [MENU] > [Maintenance], then press the [ENTER] key.
 - The Maintenance menu is displayed.
- 2** Select [Station] > [Carriage Out] > [Head Maint.], then press the [ENTER] key.
 - The carriage moves to the maintenance space.
- 3** Open the maintenance covers.

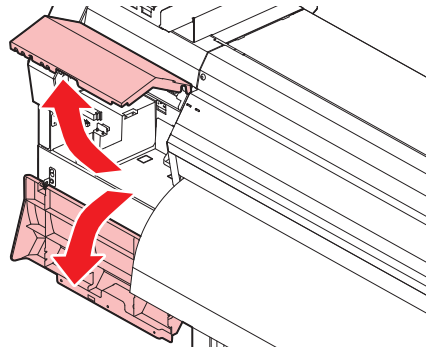

4 Clean the underside of the UV-LED lamp.

- Wipe off any ink adhering to the UV-LED lamp underside using a cleaning stick moistened with washing liquid.
- Wipe off the washing liquid. Make sure none remains.

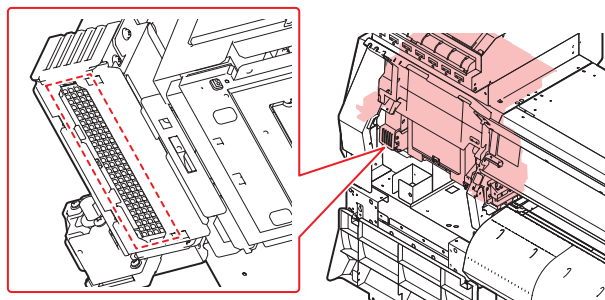

5 Clean around the print head on the underside of the carriage.

- Wipe off any ink adhering to the carriage underside using a cleaning stick moistened with washing liquid.
- Wipe off the washing liquid. Make sure none remains.

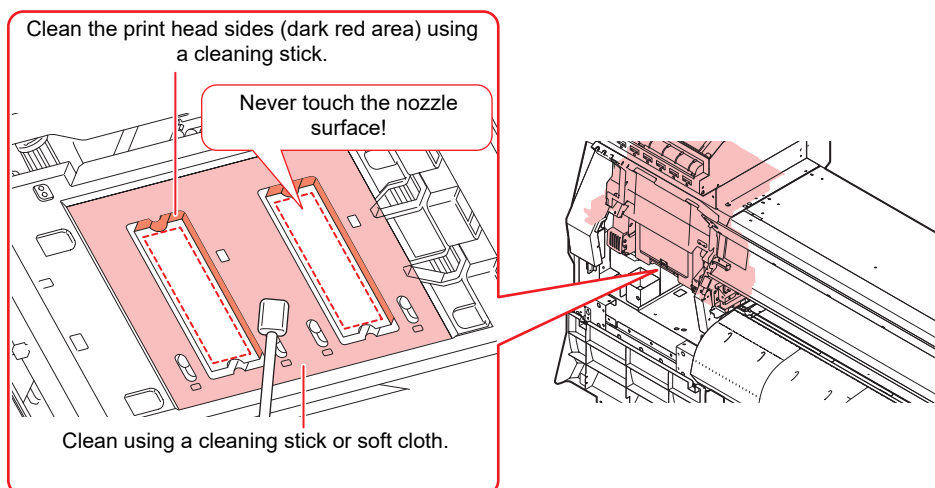



- Never touch the print head nozzle surface.

- 6** Press the [ENTER] key once cleaning is complete.
- 7** Close the maintenance covers, then press the [ENTER] key.

Cleaning the Mist Filter

The mist filter absorbs the mist generated when ink droplets are discharged from the print head. Continuing to use it when it is dirty will result in contaminated prints.

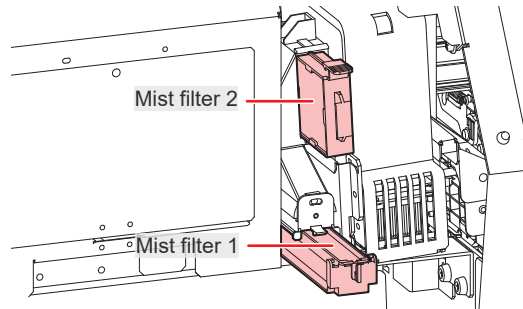

- 1** In LOCAL mode screen, select [MENU] > [Maintenance], then press the [ENTER] key.
 - The Maintenance menu is displayed.
- 2** Select [Station] > [Carriage Out] > [Head Maint.], then press the [ENTER] key.
 - The carriage moves to the maintenance space.
- 3** Open the maintenance covers.

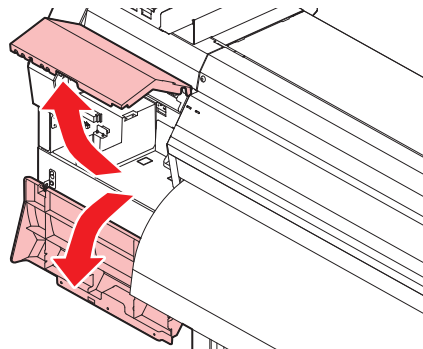

4 Remove the mist filter.

- To remove the mist filter, pull the knob to the front while pushing the tabs in the direction indicated by the arrow.

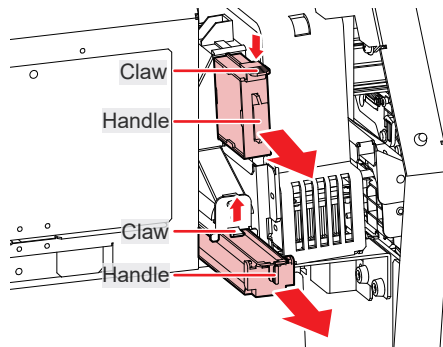

5 Clean the filter.

- Remove the filter and press it down with a paper towel to remove dirt.
- Wipe off the dirt adhering to the filter case.



- Replace the mist filter if it gets very dirty—for example, due to liquefaction of ink adhering to the filter.

 ["Mist Filter Replacement"\(P. 155\)](#)

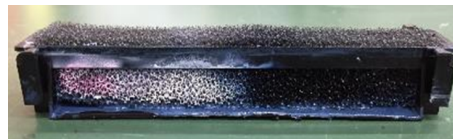

6 Return the mist filter to its original position.

7 Close the maintenance covers, then press the [ENTER] key.

Print Head Nozzle Washing

If print defects (e.g., nozzle clogging, deflection) remain unresolved even after head cleaning ( ["Head Cleaning"\(P. 69\)](#)), apply nozzle washing to the print head.

1 In LOCAL mode screen, select [MENU] > [Maintenance], then press the [ENTER] key.

- The Maintenance menu is displayed.

2 Select [Station] > [Nozzle Wash], then press the [ENTER] key.

- The carriage moves over the platen.

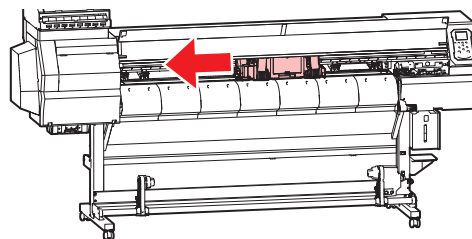

3 Open the front cover.

4 Clean the wiper and bracket.

 **"Wiper Cleaning"(P. 132)**

5 Press the [ENTER] key once cleaning is complete.

- "Cap Cleaning Completed (Next)[ENT]" appears on the display.

6 Clean the cap rubber.

 **"Cap Cleaning"(P. 134)**

7 Press the [ENTER] key once cleaning is complete.

- "Fill the Liquid. Exit Next [ENT]" appears on the display.

8 Fill the cap with washing liquid.

- Use a syringe to draw up some washing liquid and fill until it almost overflows from the cap.

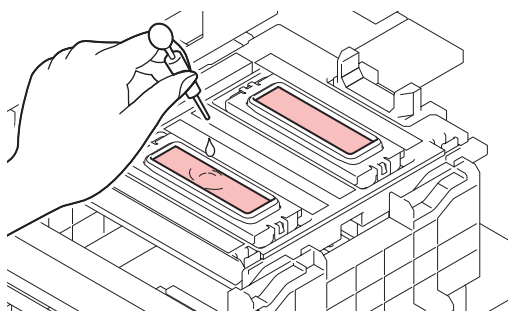
**9 Close the front cover, then press the [ENTER] key.**

- Print nozzle washing starts. The elapsed time is displayed on the display. Nozzle washing takes approximately one minute.
- Cleaning is performed automatically once print nozzle washing has ended.



- If print defects (e.g., nozzle clogging, deflection) remain unresolved even after washing the nozzles several times, contact your local dealer or our service office.

Ink Discharge Channel Cleaning

Clean the ink discharge channel regularly to prevent clogging of the ink discharge channel below the cap.

1 In LOCAL mode screen, select [MENU] > [Maintenance], then press the [ENTER] key.

- The Maintenance menu is displayed.

2 Select [Station] > [DISWAY WASH], then press the [ENTER] key.

- The carriage moves over the platen.

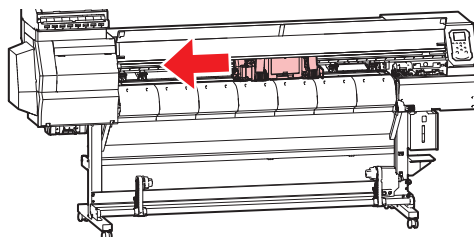
**3 Open the front cover.**

4 Fill the cap with washing liquid.

- Use a syringe to draw up some washing liquid and fill until it almost overflows from the cap.

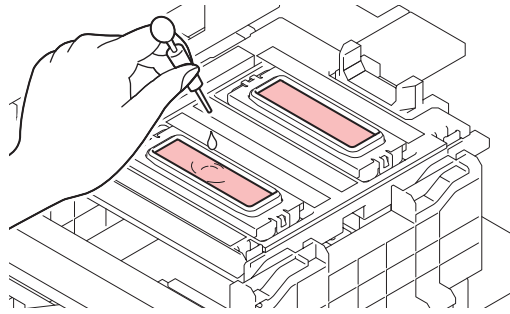

5 Close the front cover, then press the [ENTER] key.

- Pump tube (ink discharge channel below the cap) washing starts.

Media Sensor Cleaning

Media sensors are located on the rear cover and carriage underside. The media cannot be detected correctly if dust or debris accumulates on the sensors. Remove any debris using cotton swabs or a soft cloth.

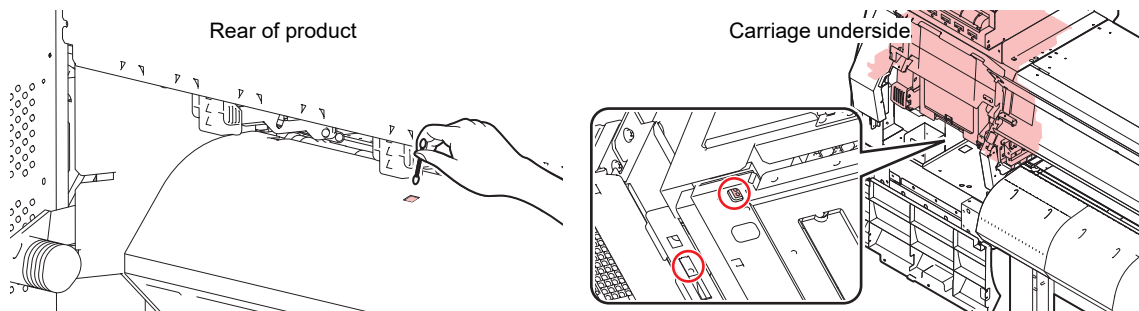

● Cleaning the carriage underside sensor

- 1** In LOCAL mode screen, select [MENU] > [Maintenance], then press the [ENTER] key.
 - The Maintenance menu is displayed.
- 2** Select [Station] > [Carriage Out] > [Head Maint.], then press the [ENTER] key.
 - The carriage moves to the maintenance space.
- 3** Open the maintenance covers.

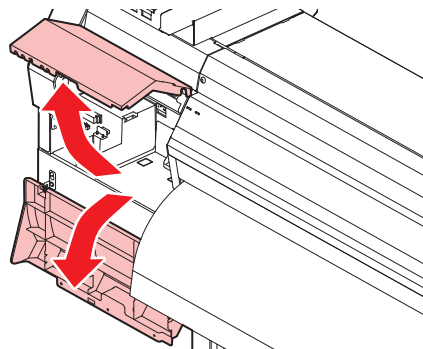

4 Clean the media sensor.

5 Close the maintenance covers, then press the [ENTER] key.

Media Holder Cleaning



- Turn off the main power and unplug the power cable before carrying out maintenance.

Continuing to use the dirty platen will prevent proper feeding of the media. It will also cause dried ink and attached dust to rub against the head nozzle surface and lead to print defects (e.g., nozzle clogging, deflection).

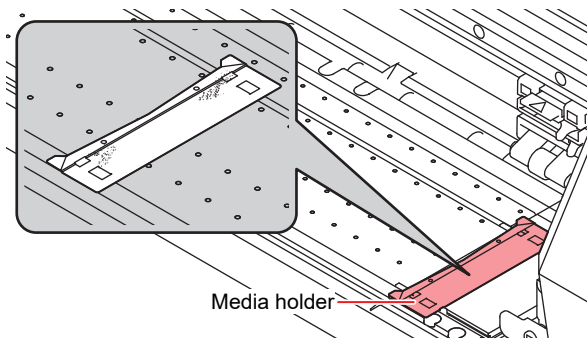

- Do not allow liquids to get inside the product. Ingress of liquids into the product may lead to failure, electric shock, or fire.



- For heavy soiling, wipe using a soft cloth soaked in dilute detergent and thoroughly wrung out.

Platen Cleaning



- Turn off the main power and unplug the power cable before carrying out maintenance.

Continuing to use the dirty platen will prevent proper feeding of the media. It will also cause dried ink and attached dust to rub against the head nozzle surface and lead to print defects (e.g., nozzle clogging, deflection).

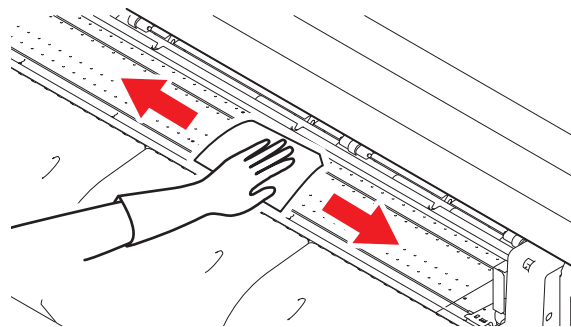

- Do not allow liquids to get inside the product. Ingress of liquids into the product may lead to failure, electric shock, or fire.



- For heavy soiling, wipe using a soft cloth soaked in dilute detergent and thoroughly wrung out.



- The grooves in which the media holder slides and the media is cut are especially susceptible to dust accumulation. Remove any debris carefully.

Cover (Exterior) Cleaning

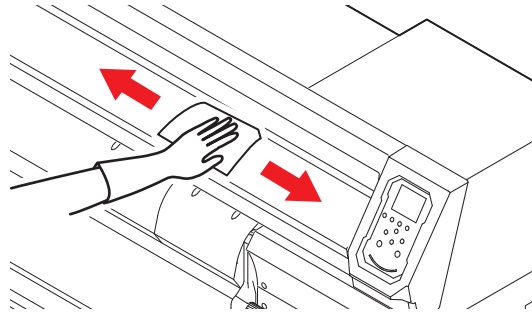

- Do not allow liquids to get inside the product. Ingress of liquids into the product may lead to failure, electric shock, or fire.



- For heavy soiling, wipe using a soft cloth soaked in dilute detergent and thoroughly wrung out.

When Not in Use for Extended Periods

Clean as follows if the product is not used for one week or longer:

Check beforehand

Is [NEAR END] or [INK END] displayed?

- Washing liquid and ink is aspirated during the washing operation. Washing is not possible if an error occurs during this process. Replace with new ink.

1 In LOCAL mode screen, select [MENU] > [Maintenance], then press the [ENTER] key.

- The Maintenance menu is displayed.

2 Select [Station] > [Custody Wash], then press the [ENTER] key.

- The carriage moves over the platen.

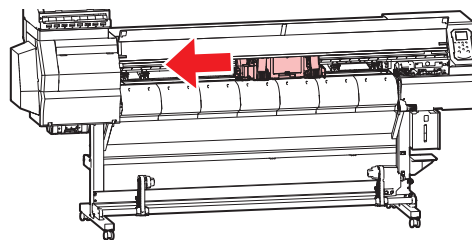

3 Open the front cover.

4 Clean the wiper and bracket.

 ["Wiper Cleaning"\(P. 132\)](#)

5 Press the [ENTER] key once cleaning is complete.

- "Cap Cleaning Completed (Next)[ENT]" appears on the display.

6 Clean the cap rubber.

 "Cap Cleaning"(P. 134)

7 Press the [ENTER] key once cleaning is complete.

- "Fill the Liquid. Exit Next [ENT]" appears on the display.

8 Fill the cap with washing liquid.

- Use a syringe to draw up some washing liquid and fill until it almost overflows from the cap.

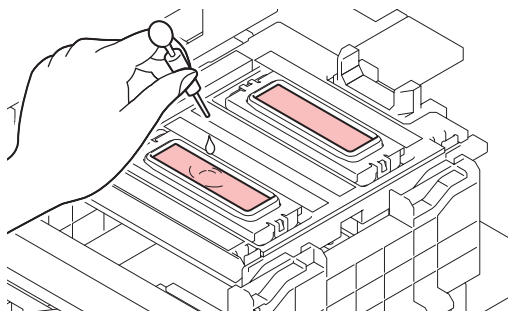

9 Close the front cover, then press the [ENTER] key.

- Print nozzle washing starts. The elapsed time is displayed on the display. Nozzle washing takes approximately one minute.
- Cleaning is performed automatically once print nozzle washing has ended.
- "Fill the Liquid. Exit Next [ENT]" appears on the display when print nozzle washing is complete.

10 Fill the cap with washing liquid.

- Use a syringe to draw up some washing liquid and fill until it almost overflows from the cap.

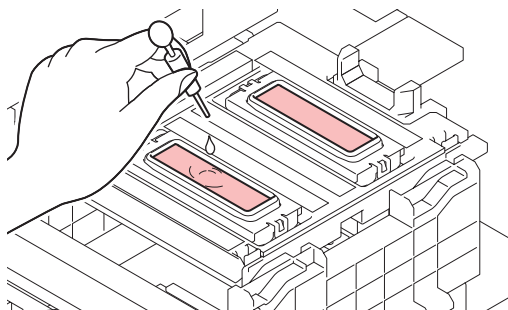

11 Close the front cover, then press the [ENTER] key.

- Pump tube (ink discharge channel below the cap) washing starts.



- Do not turn off the main power supply. Turning off the main power supply will disable the automatic maintenance function (including nozzle clogging prevention function and ink discharge channel cleaning function) and may result in printing defects (such as nozzle clogging and deflection) or other faults.

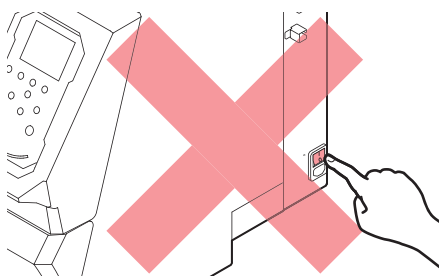



- Do not leave media loaded on the platen. This may leave irregularities or ripples in the media.



- When this product is not in use, raise the clamp lever to separate the pinch rollers from the grid rollers. If the pinch rollers are left in the lowered position for an extended period of time, they may become deformed, possibly preventing the media from being fed correctly.



- Perform the following if the "Check Waste Ink Tank" message appears on the display.
 ["Waste Ink Tank Replacement"\(P. 148\)](#)
-

6.3 Consumable Item Replacement

To order replacement consumable items, contact your local dealer or our service office.

For more information on consumable items, refer to our website.

<https://mimaki.com/supply/inkjet.html>



- When disposing of the product, contact an industrial waste disposal operator or dispose of the product in accordance with the local laws and regulations.



- Do not store in places accessible to children.

Wiper Replacement

This product maintains a count of the number of wiping cycles. The “Replace Wiper” message appears when a preset count is reached. Replace dirty or warped wipers with new ones.

- 1 “Replace Wiper” appears on the display.
- 2 In LOCAL mode screen, select [MENU] > [Maintenance], then press the [ENTER] key.
 - The Maintenance menu is displayed.
- 3 Select [Station] > [Replace Wiper], then press the [ENTER] key.
 - The carriage moves over the platen.

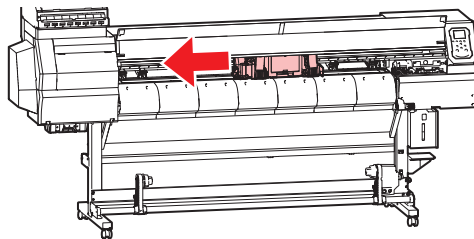

- 4 Open the front cover.

- 5 Pull out the wiper.
 - Pull out the wiper by holding the protrusions at both ends.

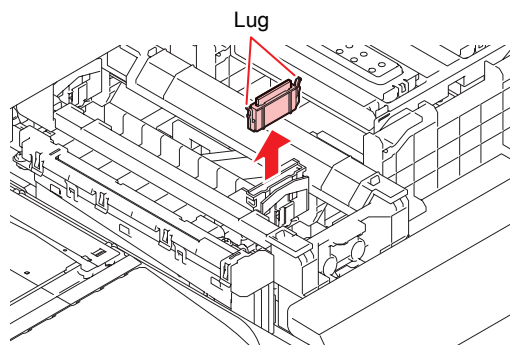

- Wipe the ink sticking to the wiper slider.

6 Insert a new wiper.

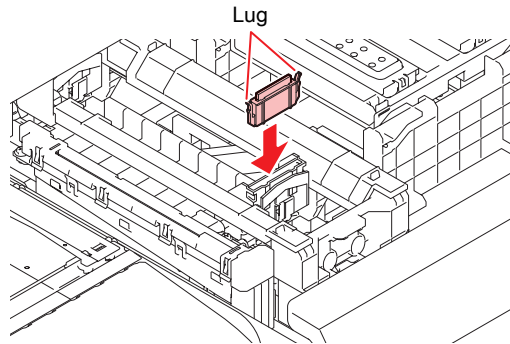

7 Press the [ENTER] key once replacement is complete.

8 Close the front cover, then press the [ENTER] key.

- The wiper usage count is reset.

Cap Absorber Replacement

This product maintains a usage count. The “Replace Cap Absorber” message appears on the display when a preset count is reached. (This is supported in firmware version 2.5 and later)

If the cap absorber is very dirty or if ink drips on to the media, replace with a new cap absorber.

1 The “Replace Cap Absorber” message appears on the display.

2 In LOCAL mode screen, select [MENU] > [Maintenance], then press the [ENTER] key.

- The Maintenance menu is displayed.

3 Select [Station] > [Carriage Out] > [Station Maint.], then press the [ENTER] key.

- The carriage moves over the platen.
- The cap absorber usage count is reset.

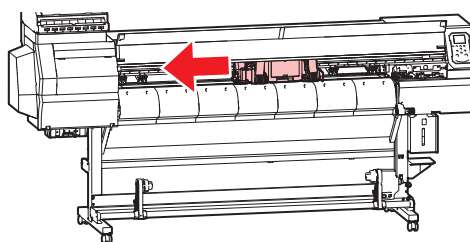

4 Turn off the power.

5 Open the front cover.

6 Remove the cap absorber.

- Push up the two tabs at the front to remove the cap absorber.

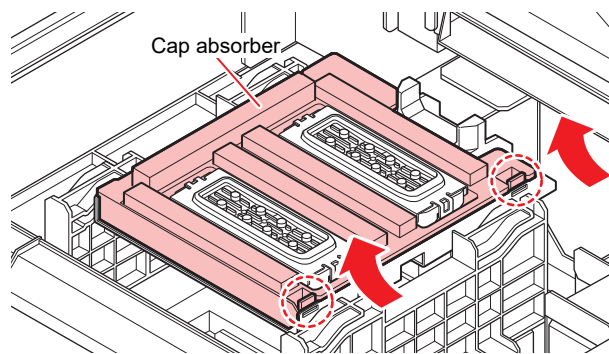

- Avoid ink dripping when removing the cap absorber.

7 Clean the carriage base.

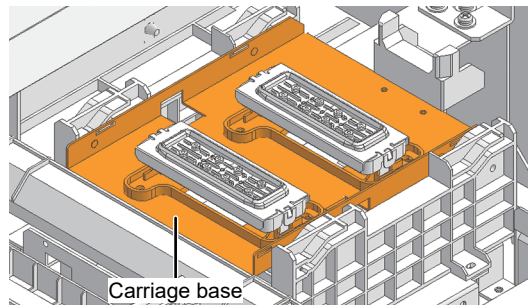

8 Attach a new cap absorber.

- Push the tabs on the cap absorber into the slits at the rear of the C slider, and clip in the tabs at the front.

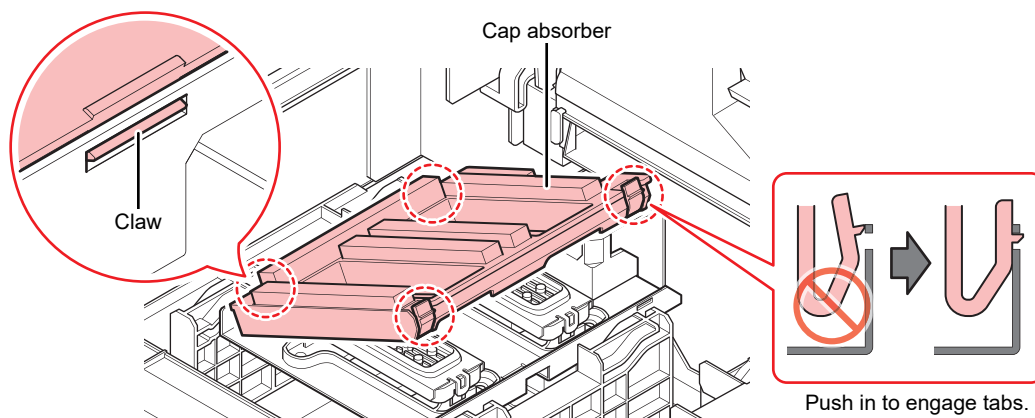

9 Once replacement is complete, close the front cover, then turn on the power.

- Check to confirm that the carriage returns to the station.

Waste Ink Tank Replacement

Ink used during head cleaning and other processes is collected in the waste ink tank at the lower right of the product.

This product keeps track of the waste ink level. A “Check Waste Ink Tank” message appears when the preset level is reached. Use this a guide for replacing the waste ink tank.





- For a 2-liter tank, the preset level is 80 % (1.6 liters).
- Continuing to use the product without disposing of the waste ink may result in waste ink overflowing from the waste ink tank. Visually check ink levels in the waste ink tank about once a week.



- Wear safety glasses, gloves, and a mask when handling ink, maintenance cleaning solution, waste ink, or other solutions used with this machine. Leaking ink may adhere to the skin or get into your eyes or mouth.



When “Check Waste Ink Tank” message appears

- 1** The “Check Waste Ink Tank” message appears on the display.
- 2** Check the waste ink levels in the waste ink tank.
 - If you note any discrepancies from actual levels, proceed to the next step.
 - If there is no discrepancy, replace (dispose of) the waste ink tank referring to  [\[Replace the waste ink tank.\]](#)(P. 149).
- 3** In LOCAL mode, select [MENU] > [Maintenance], then press the [ENTER] key.
 - The Maintenance menu is displayed.
- 4** Select [Replace Wasteinktank], then press the [ENTER] key.
 - “Replace Wasteinktank Level: 80% (1.6L)” appears on the display.
- 5** Press  to adjust the level.
- 6** Press the [ENTER] key once adjustment is complete.

Replace the waste ink tank.

- 1** In LOCAL mode screen, select [MENU] > [Maintenance], then press the [ENTER] key.
 - The Maintenance menu is displayed.
- 2** Select [Replace Wasteinktank], then press the [ENTER] key.
 - “Replace Wasteinktank Level: 80% (1.6L)” appears on the display.

3 Open the waste ink tank cover.

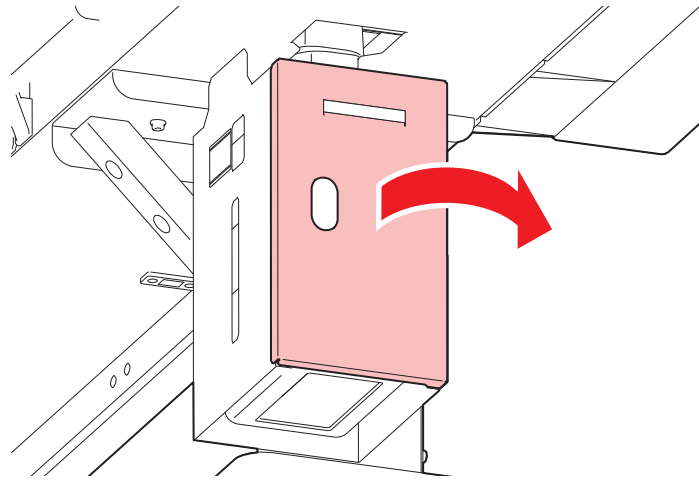

4 Hold the handle on the waste ink tank and slide out.

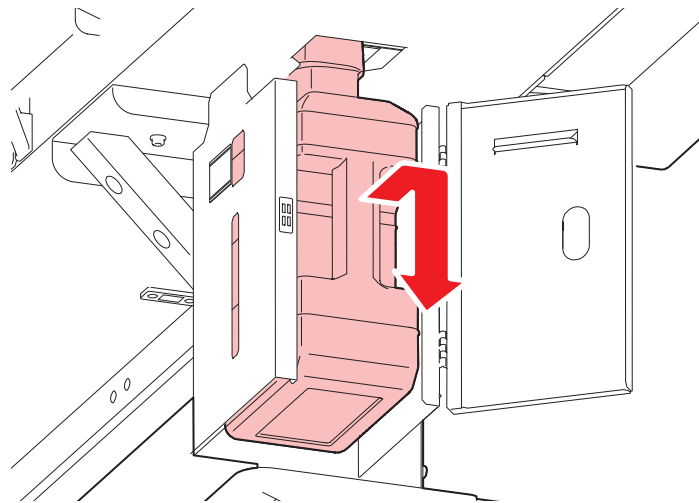

5 Attach the cap to the removed waste ink tank, and use tape to prevent leakage of waste ink.

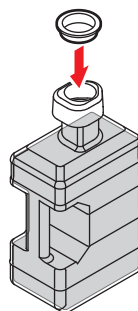

- When disposing of the product, contact an industrial waste disposal operator or dispose of the product in accordance with the local laws and regulations.

6 Insert a new waste ink tank.

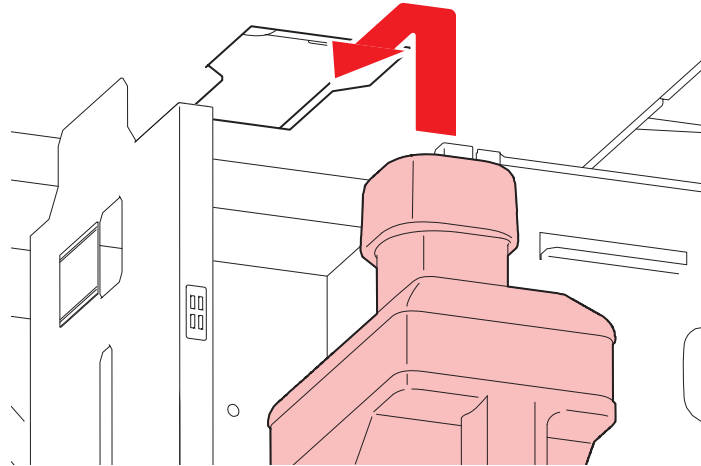

7 Close the waste ink tank cover.

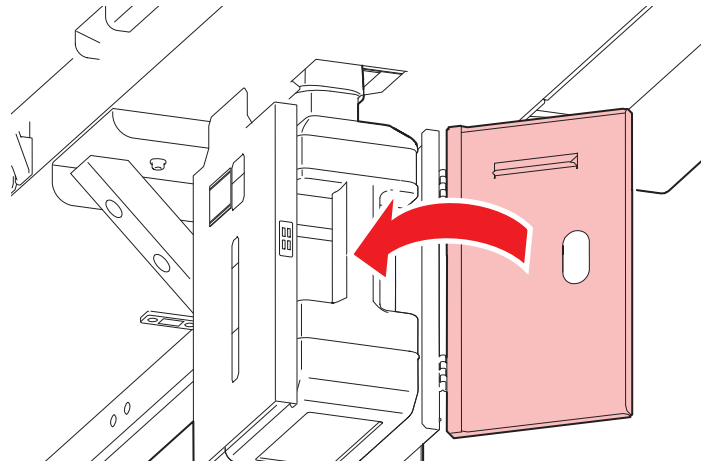

8 Press the [ENTER] key.

- The waste ink level will be reset.

Exhaust Fan Filter Replacement

Check the exhaust fan filter condition. Replace if very dirty.

1 Remove the exhaust fan BOX.

- Push the tabs at the front to remove the exhaust fan BOX.

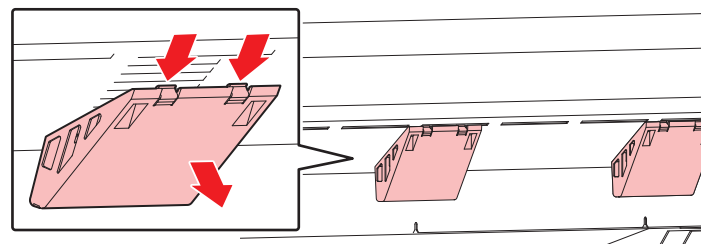

- Replace the very dirty exhaust fan BOX with new one.

2 Attach a new exhaust fan filter to the exhaust fan BOX.

- Insert the exhaust fan filter into the space under the tabs of the exhaust fan BOX.

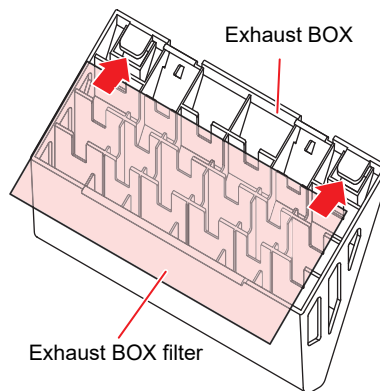

3 Attach the exhaust fan BOX.

- Push the tabs of the exhaust fan BOX into the slits of the machine, and clip in the tabs at the front.

Pinch Roller Replacement

Replace worn or dirty pinch rollers with new ones.



- The pinch rollers are small. Be careful to avoid dropping them into the product interior.



- Turn off the main power and unplug the power cable before replacing the pinch rollers.

1 Open the front cover.

2 Raise the clamp lever.

3 Remove the O-ring retaining the pinch rollers.

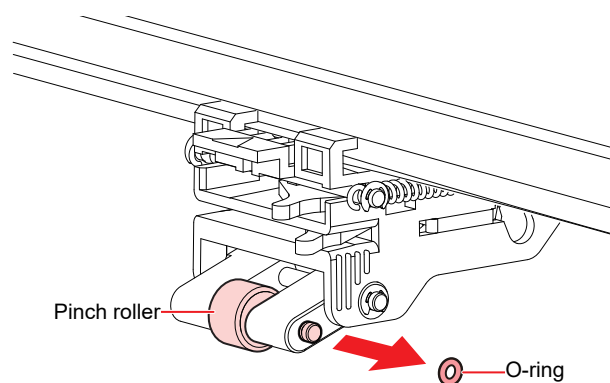

4 Remove the pinch roller spindle.

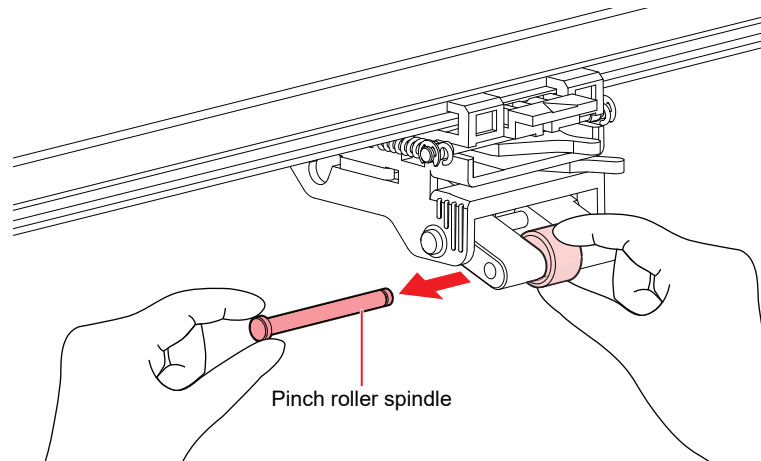

5 Attach new pinch rollers, and secure them using the O-ring.

6 Close the front cover.

Media Holder Replacement

If the media holder becomes deformed and touches the carriage or print head, replace with a new media holder.



- Turn off the main power and unplug the power cable before replacing the pinch rollers.

1 Open the maintenance covers.

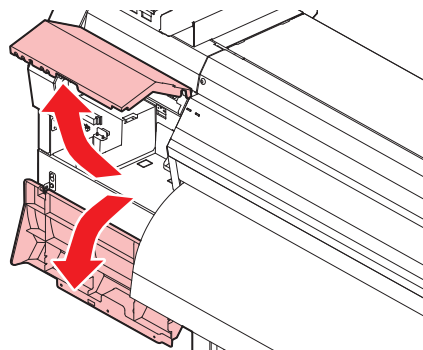

2 Remove the side screw, and detach the media holder stopper.

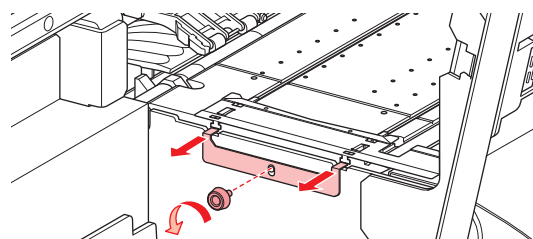

3 Remove the media holder.

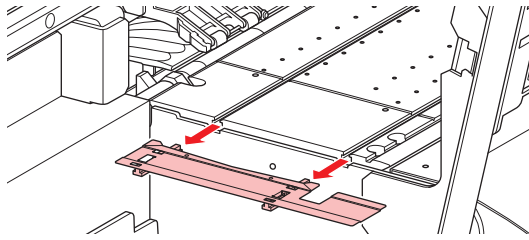

4 Remove the sliders from the media holder.

- Be careful to avoid misplacing the sliders.

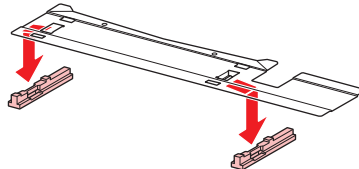

5 Attach the sliders to the new media holder.

- Engage the holes in the sliders on to the lugs on the media holder.

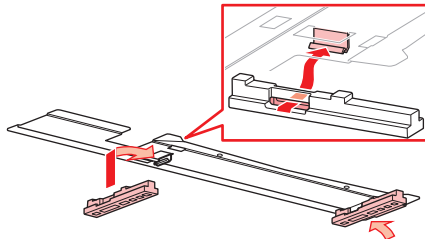

6 Insert the new media holder into the platen.

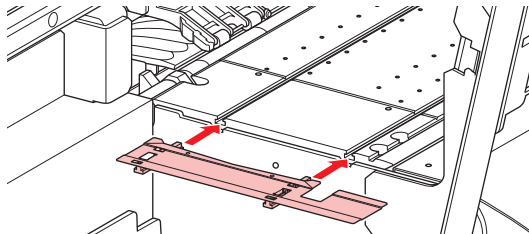

7 Attach the media holder stopper, and tighten the screw.

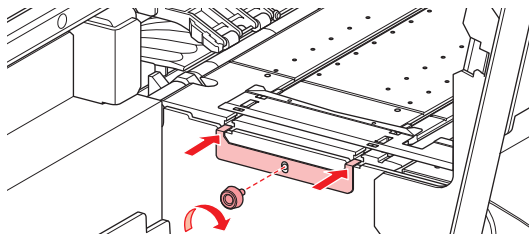

8 Close the maintenance covers.

Media Cutter Replacement

Replace cutters when blades are chipped or blunt.



- Do not touch the cutter blade. Disregarding this precaution may result in injury.



- Do not store in places accessible to children.

1 In LOCAL mode screen, select [MENU] > [CUTTING], then press the [ENTER] key.

- The Cutting menu is displayed.

2 Select [TOOL CHANGE], then press the [ENTER] key.

- The cutter unit moves over the platen.

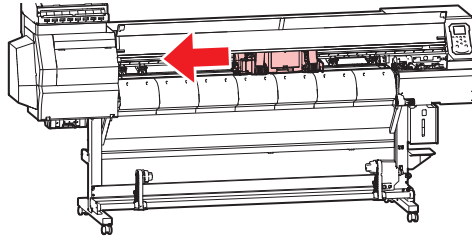

3 Open the front cover.



- The cutter unit can be moved manually. Move the carriage slowly to a position allowing easy access for replacing the cutter.

4 Replace the media cutter.

- (1) Unscrew the cutter screw.

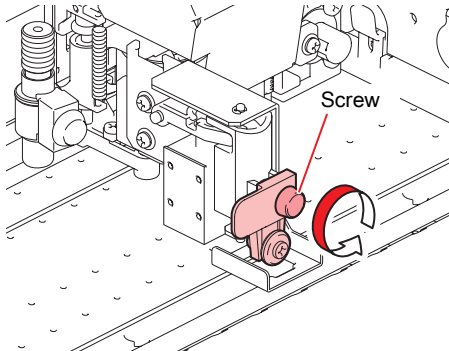

- (2) Remove the cutter.
- (3) Attach a new cutter.
- (4) Tighten the screw to clamp the cutter.

5 Press the [ENTER] key once replacement is complete.

6 Close the front cover, then press the [ENTER] key.



- When disposing of the product, contact an industrial waste disposal operator or dispose of the product in accordance with the local laws and regulations.

Mist Filter Replacement

Check the mist filter. Replace if very dirty.

- 1** In LOCAL mode screen, select [MENU] > [Maintenance], then press the [ENTER] key.
 - The Maintenance menu is displayed.
- 2** Select [Station] > [Carriage Out] > [Head Maint.], then press the [ENTER] key.
 - The carriage moves to the maintenance space.
- 3** Open the maintenance cover.

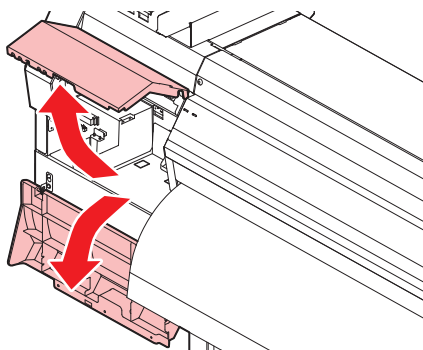

- 4** Remove the mist filter BOX.
 - Push the tabs in the direction indicated by the arrow and slide to the side to remove.

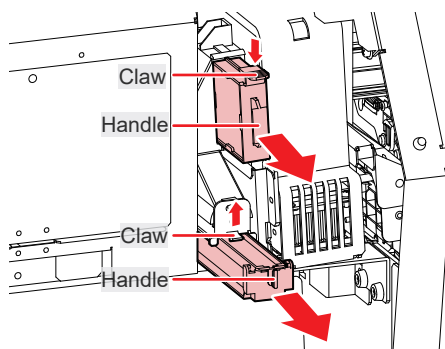

- 5** Replace the mist filter with a new one.
- 6** Insert the mist filter BOX.
 - Insert until it clicks into place. Confirm that the tabs is engaged.
- 7** Press the [ENTER] key once replacement is complete.
- 8** Close the maintenance covers, then press the [ENTER] key.

LED Glass Replacement

Replace with new LED glass if the ink hardens and the existing LED glass becomes dirty.

- 1** In LOCAL mode screen, select [MENU] > [Maintenance], then press the [ENTER] key.
 - The Maintenance menu is displayed.
- 2** Select [Station] > [Carriage Out] > [Head Maint.], then press the [ENTER] key.
 - The carriage moves to the maintenance space.

3 Open the maintenance cover.

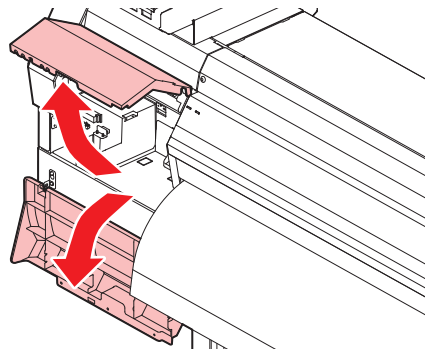

4 Remove the LED glass.

- Unclip the tabs and slide to the side to remove.
- Be careful not to apply too much force when unclipping the tabs. Disregarding this precaution may result in breakage of the tabs.

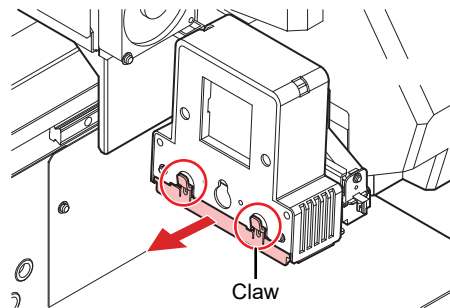

5 Insert new LED glass.

- Insert until it clicks into place. Confirm that the tabs are engaged.

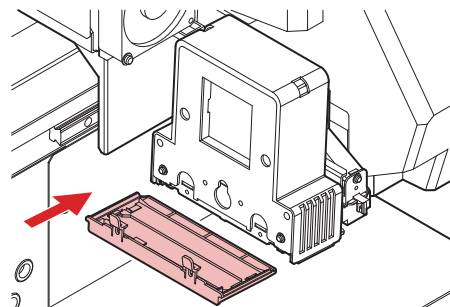

6 Press the [ENTER] key once replacement is complete.

7 Close the maintenance covers, then press the [ENTER] key.

6.4 Consumable Item Replacement (Cutting Related)

Replace cutters when blades are chipped or blunt.

To order replacement consumable items, contact your local dealer or our service office.

Item	Code
Pen adapter	SPA-0169
Eccentric cutter holder	SPA-0001
Eccentric cutter holder	SPA-0090
Eccentric blade for PVC sheets	SPB-0001
Eccentric blade for small letters	SPB-0003
Eccentric blade for rubber sheets	SPB-0005
Eccentric blade for reflective sheets	SPB-0006
Eccentric blade for fluorescent sheets	SPB-0007
Low pressure eccentric blade for PVC sheets	SPB-0030
Eccentric blade for thick rubber sheets	SPB-0084

For more information on other consumable items, refer to our website.

<https://mimaki.com/supply/inkjet.html>

● Replacing Cutters

 "Installing Cutting Tools"(P. 82)



- Avoid touching the cutter blade. Doing so may lead to injury.
- Do not shake or swing the cutter holder. Doing so may cause the blade to come off.



- Do not store in places accessible to children.



- When disposing of the product, contact an industrial waste disposal operator or dispose of the product in accordance with the local laws and regulations.

Pen Line Replacement

This machine can be used with the following pen lines.

- Pen line rubber
Used for pen writing or cutting
- Pen line sponge
Used for half cut (cutting across a dotted line)

To order replacement consumable items, contact your local dealer or our service office.

Item	Code
PEN LINE RUBBER FOR 300/150-160	SPC-0770
PEN LINE RUBBER FOR 300/150-130	SPC-0771
PEN LINE RUBBER FOR 150-107	SPC-0772
PEN LINE RUBBER FOR 150-75	SPC-0773

Item	Code
PEN LINE SPONGE FOR 300/150-160	SPC-0775
PEN LINE SPONGE FOR 300/150-130	SPC-0776
PEN LINE RUBBER FOR 150-107	SPC-0777
PEN LINE RUBBER FOR 150-75	SPC-0778

For more information on other consumable items, refer to our website.

<https://mimaki.com/supply/inkjet.html>

- 1** Open the front cover.
- 2** Use tweezers to peel off the end of the pen line.
 - Wipe off any adhesive remaining in the platen slot with alcohol.

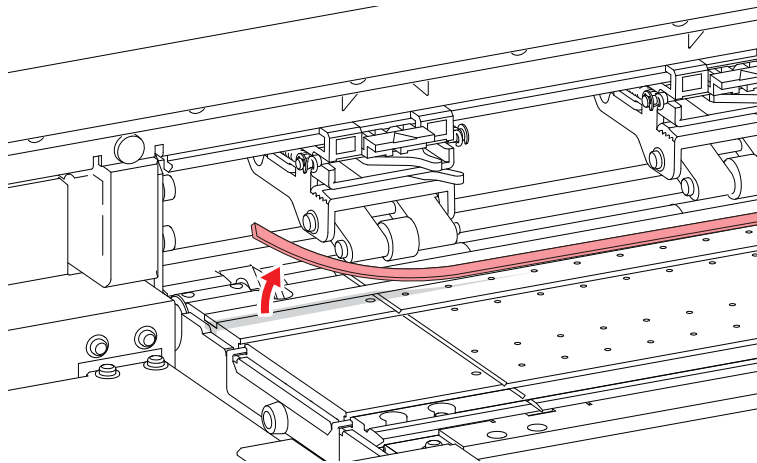

- 3** Attach double-sided tape in the platen slot.
 - Peel off the base paper from the double-sided tape.
- 4** Attach the pen line on the double-sided tape.
 - Make sure the pen line lies flat.
- 5** Close the front cover.

Chapter 7 Dealing with Problems



This chapter

This chapter explains procedures for troubleshooting and addressing messages on the display.

Troubleshooting.....	162	The light-blocking cover comes off.	167
The power does not turn on.	162	Cutting Related	167
Printing is not possible.	162	Problems indicated by messages.....	172
The media jams or the media is dirty.	162	Warning messages	172
Image defects occur.....	163	Ink errors (local guidance)	174
Ink leakage occurs.	163	Error messages.....	175
Ink colors are mixed.....	163	SYSTEM HALT	181



7.1 Troubleshooting

For information on troubleshooting, refer to this chapter. Refer to the following URL for frequently asked questions (FAQs) about this product and customer support videos.





<https://mimaki.com/support/>

If the recommended corrective action does not resolve the problem, contact your local dealer or our service office.

The power does not turn on.

Points to check	Corrective action
Is the machine connected to the power outlet by the power cable?	Connect the power plug securely to the power outlet.  "Connecting the Power Cable"(P. 32)
Are you using the power cable provided?	Use the power cable provided.
Is the main power supply turned on?	Turn on the main power.  "Turning On the Power"(P. 32)
Is the [END/POWER] key on the operating panel turned on?	Turn the power on.  "Turning On the Power"(P. 32)

Printing is not possible.

Points to check	Corrective action
Is a USB 2.0 interface cable connected?	Connect the cable securely to the USB 2.0 port.  "Using a USB 2.0 Interface Cable"(P. 34)
Is a LAN cable connected?	Connect the cable securely to the LAN port.  "Using a LAN Cable"(P. 34)
Are you using a LAN cable approved by Mimaki?	Check the LAN cable type.  "Network Connection Precautions"(P. 35)
Is the status lamp on the operating panel illuminated or flashing red?	An error has occurred. Check the message on the display.  "Operating panel"(P. 28)

The media jams or the media is dirty.



Points to check	Corrective action
Are you using the recommended media?	Make sure you are using the recommended media. https://mimaki.com/supply/inkjet.html
Are you using curled media?	Do not use curled media or media with folded ends.  "Loading the Media"(P. 57)
Is the media skewed?	Use the take-up unit to adjust the media or reload the media.  "Loading the Media"(P. 57)
Does the media have ripples/surface irregularities?	If you are using roll media, use a smooth section of the media for initial feeding.  "Loading the Media"(P. 57)

Image defects occur.

Symptom	Corrective action
White streaks, blurriness, and dark streaks occur. (Carriage scan direction)	<ol style="list-style-type: none"> 1. Remove any paper scraps or other debris adhering to areas over which the head passes (e.g., media holders). "Media Holder Cleaning"(P. 142) "Platen Cleaning"(P. 142) 2. Perform the procedure described in "Head Cleaning"(P. 69). 3. Perform the procedure described in "Feed Correction"(P. 70). 4. Perform the procedure described in "Wiper Cleaning"(P. 132). 5. Perform the procedure described in "Cap Cleaning"(P. 134). 6. Perform the procedure described in "Carriage Underside Cleaning"(P. 136).
Text is double- or triple-printed in the media feed direction.	<ol style="list-style-type: none"> 1. Perform the procedure described in "Feed Correction"(P. 70).
Offsetting occurs during bidirectional printing.	<ol style="list-style-type: none"> 1. Perform the procedure described in "Correcting the Drop Position"(P. 72).
Ink droplets drip during printing.	<ol style="list-style-type: none"> 1. Perform the procedure described in "Wiper Cleaning"(P. 132). 2. Perform the procedure described in "Cap Cleaning"(P. 134). 3. Clean around the head. "Carriage Underside Cleaning"(P. 136) 4. Perform the procedure described in "Head Cleaning"(P. 69). 5. "Maintenance Menu"(P. 113)
Clear clogged nozzles.	<ol style="list-style-type: none"> 1. Perform the procedure described in "Head Cleaning"(P. 69). 2. Perform the procedure described in "Print Head Nozzle Washing"(P. 139). 3. Perform [MENU] > [Maintenance] > [INK FILL]. 4. Perform the procedure described in "Wiper Replacement"(P. 146). 5. Perform the procedure described in "Registering nozzle recovery"(P. 114).
The white image is offset in the media feed direction.	<ol style="list-style-type: none"> 1. Perform the procedure described in "Feed Correction"(P. 70).

Ink leakage occurs.



- If an ink leak occurs, turn off the main power immediately and unplug the power cable. Contact your local dealer or our service office.

Ink colors are mixed.

● Items Required for Maintenance

To order replacement consumable items, contact your local dealer or our service office.

Item	Code
Paper towel (KIM TOWEL)	SPC-0499
KIMWIPE S-200	SPA-0207
Safety glasses	
Gloves	

For more information on other consumable items, refer to the following URL:
<https://mimaki.com/supply/inkjet.html>



- Wear safety glasses, gloves, and a mask when handling ink, maintenance cleaning solution, waste ink, or other solutions used with this machine. Leaking ink may adhere to the skin or get into your eyes or mouth.



- 1 In LOCAL mode screen, select [MENU] > [Maintenance], then press the [ENTER] key.**
 - The Maintenance menu is displayed.
- 2 Select “AIR PG”, then press the [ENTER] key.**
- 3 Select the checkbox corresponding to the head to be air-purged. (This does not apply to the UCJV150 Series.)**
 - The checked head becomes the air purge target.
 - With the 300 Series, you can simultaneously select Head 1 and Head 2.

Ink set	Head 1				Head 2			
4-color	C	M	Y	K	Y	K	M	C
6 colors + W	C	M	Y	K	Lm	Lc	W	W
4 colors + CL + W	C	M	Y	K	CL	CL	W	W
4 colors + W	C	C	M	M	Y	K	W	W

- 4 Press the [ENTER] key.**
 - The target head moves over the wiper.
- 5 Open the front cover.**
- 6 Open the lid on the front of the carriage.**
 - Remove the screw, then slowly lower the lid.

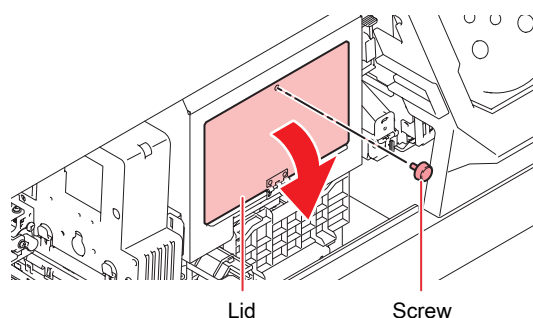

7 Remove the cap on the target port.

- If you select Head 1 and Head 2 simultaneously, remove the cap on the port of the head displayed at the upper right of the display.
- Turn the cap 30° counterclockwise and remove.
- No ink spills out even if the cap is removed.
- Ink adheres to the removed cap. Place on a paper towel to avoid contaminating the surrounding area.
- Purge air from the print heads one by one. Do not remove the cap on Head 2 when performing air purge for Head 1.

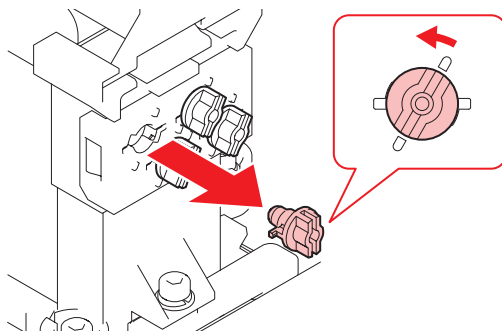

Model	Ink set	Head 1	Head 2
UCJV300	4 colors: CMYK YKMC	C Y M K	Y M K C
	6 colors + W: CMYK LmLcWW	C Y M K	Lm W Lc W
	4 colors + CL + W: CMYK CLCLWW	C Y M K	CL W CL W
	4 colors + W: CCMM YKWW	C M C M	Y W K W
UCJV150	4 colors: CMYK	C Y M K	N/A

8 Connect the jig to the port.

- Lift the lid on the front of the carriage and pull out the jig.

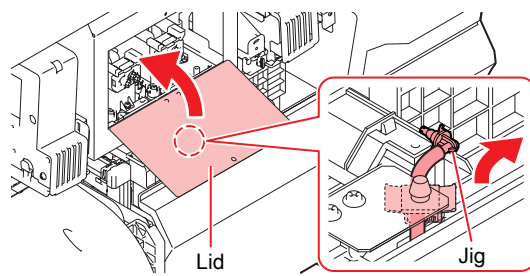

- Connect the jig by pushing the tip into the port and rotating 30° clockwise.

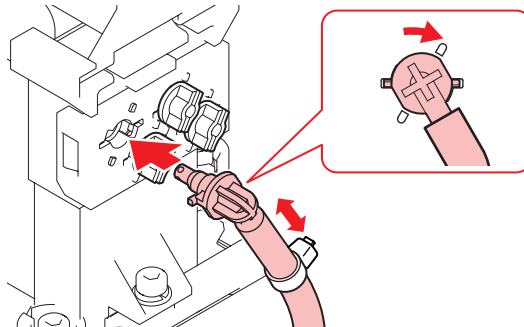
**9 Press the [ENTER] key to start the air purge.****10 Check to confirm ink flows in the tube of the jig.**

- Continue air purge until no mixed ink colors or air remains. Remove the jig and press the [ENTER] key to end the air purge.
- Air purge will stop automatically after 30 seconds. To continue the air purge, select [Retry].



- Do not repeat any of these operations for the same port. Doing so may lead to nozzle clogging. End the air purge when no mixed ink colors or air remains.



- During air purge, press [FUNC2] to force ink discharge for three seconds.

11 Repeat the above procedure for the other target ports.**12 Press the [ENTER] key once the air purge is complete.****13 Remove the jig from the port.**

- Turn the jig 30° counterclockwise and remove.

14 Attach the cap to the port.

- Vertically lift the tip of the jig and drain the ink from the tube. Any ink left in the tube may harden.

15 Close the lid on the front of the carriage.

16 Close the front cover, then press the [ENTER] key.

- Cleaning starts automatically.
- If you select Head 1 and Head 2 simultaneously, follow the instructions on the display to perform the air purge.

The light-blocking cover comes off.



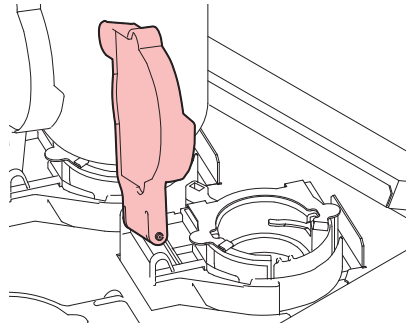
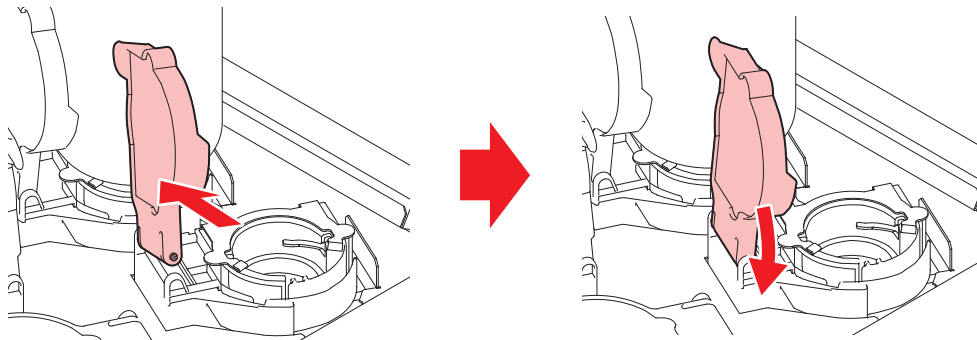

If the light-blocking cover comes loose, the ink inside the tank may be exposed to light and begin to harden. If the light-blocking cover comes loose, reattach as follows:

1 Insert the lug on one side of the light-blocking cover into the corresponding hole in the tank.**2** Insert the lug on the other side while pushing in toward the first hole in Step 1.**Cutting Related**

Symptom	Corrective action
The cut position shifts.	This may indicate a problem with the register mark sensor. Perform the operation used to check the responsiveness of the register mark sensor. You cannot check the responsiveness of the register mark sensor manually. ☞ "Adjusting the Position of the Register Mark Sensor"(P. 168)
Cutting is not possible.	Cut a sample stored in the machine to identify the cause. Executing a sample cut will clear any data saved in the receive buffer. ☞ "Investigating the Cause of Cutting Failures"(P. 170)
The print and cut positions are misaligned.	Use the MIMAKI RIP software (RasterLink) to print a correction pattern. Check the correction pattern and input correction values manually. ☞ "Adjusting to Correct Misalignment Between Printing and Cutting"(P. 170)

Symptom	Corrective action
The print and cut positions are misaligned in the scan direction.	Print the correction pattern to perform automatic correction. <ol style="list-style-type: none"> Load the media. <ul style="list-style-type: none"> Prepare white media used to print a correction pattern. In LOCAL mode screen, select [MENU] > [CUTTING], then press the [ENTER] key. <ul style="list-style-type: none"> The Cutting menu is displayed. Select [MAINTENANCE] > [SCALE ADJUST], then press the [ENTER] key. When the confirmation screen is displayed, press the [ENTER] key. <ul style="list-style-type: none"> Print the correction pattern to perform automatic correction.

Adjusting the Position of the Register Mark Sensor

- Prepare the media on which register marks are printed.
 -  ["Creating Register Marks"\(P. 98\)](#)
- In LOCAL mode screen, select [MENU] > [CUTTING], then press the [ENTER] key.
 - The Cutting menu is displayed.
- Select [MAINTENANCE] > [MARKS SENSOR] > [SENSOR CHK], then press the [ENTER] key.
 - The cutting unit moves over the platen.
- Press     to move the LED pointer.

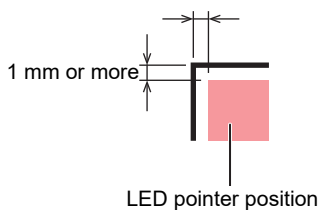
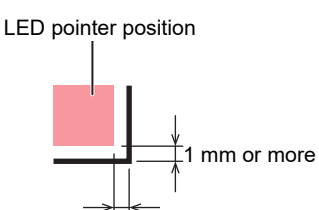
Mark shape	
Type 1	Type 2
	

- Register the information corresponding to the printed register mark conditions.
 -  ["Setting Mark Detection Conditions"\(P. 103\)](#)
 - The set register mark conditions are also stored in [CUTTING] > [TP DETECT]. The settings are retained even when the power is turned off.

6 Press [ENTER] to start the detection operation.

- The machine automatically detects the lines in the X and Y directions (automatic detection operation: plus X direction > minus X direction > plus Y direction > minus Y direction).

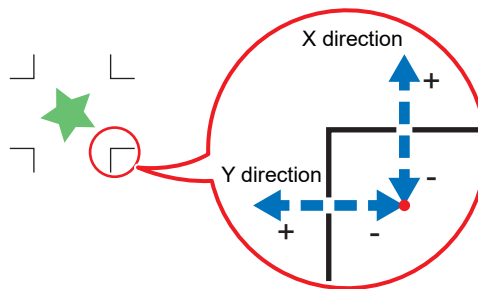

- A buzzer sounds each time a line is detected (four buzzers in all). If any of the buzzers fails to sound, refer to the following:

["Correcting the LED Pointer Position"\(P. 169\)](#)

Correcting the LED Pointer Position

If the register marks cannot be read properly, the register mark sensor may be misaligned. Refer to the following to correct the position of the register mark sensor:

1 Attach a pen to the tool holder.

- ["Using a Pen"\(P. 86\)](#)

2 Load copy paper.

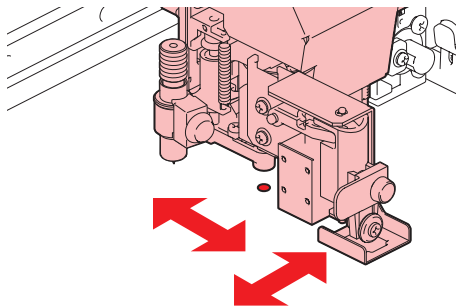

3 In LOCAL mode, select [MENU] > [CUTTING], then press the [ENTER] key.

- The Cutting menu is displayed.

4 Select [MAINTENANCE] > [MARKS SENSOR] > [POINTER OFFSET], then press the [ENTER] key.

- A 10 mm cross pattern is drawn.
- The LED pointer turns on and moves to the center of the cross pattern.

5 Press to move the LED pointer to the center of the cross pattern.

6 Press the [ENTER] key to complete the settings.



- The settings are retained even if [SETUP RESET] is selected.



7 Check the following again.

-  "Adjusting the Position of the Register Mark Sensor"(P. 168)
- If the buzzer does not sound four times, check the printed register mark conditions and contact your local distributor, our sales office, or service center.

Investigating the Cause of Cutting Failures

- 1** In LOCAL mode screen, select [MENU] > [CUTTING], then press the [ENTER] key.
 - The Cutting menu is displayed.
- 2** Select [MAINTENANCE] > [SAMPLE CUT], then press the [ENTER] key.
- 3** Select the sample data, then press the [ENTER] key.
 - There are two sample types: "Cut" and "Logo".

Sample	
Cut	Logo
	

- If you select "Cut", press the [ENTER] key to start cutting.
- If you select "Logo", refer to the following:
 - (1) Press   to specify the scaling factor (1 to 999 %).
 - (2) Press the [ENTER] key to start cutting
 - The settings are retained even if [SETUP RESET] is selected.

● Sample Cut Results

- Sample data can be cut properly, but not other data.
 - There is a problem with the host PC.
- Sample data as well as other data cannot be cut properly.
 - There is a problem with the printer. Increase the pressure in the ADJ-PRS OFFSET menu.
 -  "Cutting Menu List"(P. 124)

Adjusting to Correct Misalignment Between Printing and Cutting

In the procedure described below, MIMAKI RIP software (RasterLink) is used to print a correction pattern. When printing and cutting without register marks, correction is required for each resolution in the scan (Y) direction. (The corrected value is saved for each resolution.) Print a pattern for each resolution, then input the correction value.

- 1** Switch the machine to REMOTE mode.
- 2** Set the print conditions (profile/cut conditions) for the job you want to print in RasterLink.

3 Click on [print & cut Origin adjust] on the [Cut edit] tab of RasterLink.

- Click [OK] to print a correction pattern.
- Select "Add register mark" to print with register marks.

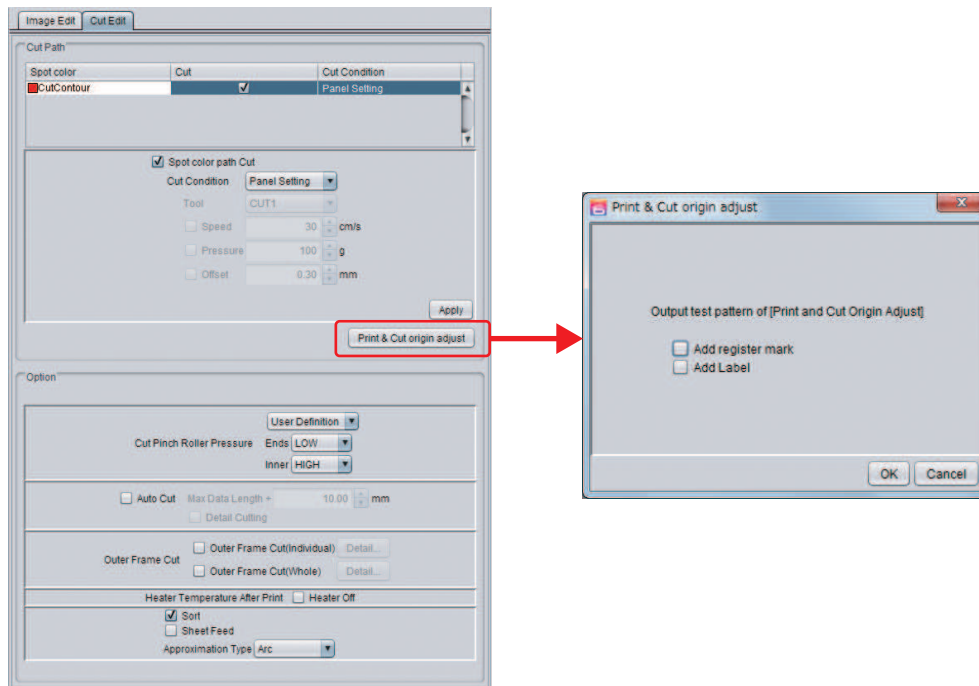

4 Enter the adjustment value.

- Without register marks
 - (1) In REMOTE mode screen, select [AJUST].
 - (2) Select [PC ORIGIN OFFSET], then press the [ENTER] key.
 - A correction pattern is cut. Detach the cut part of the pattern and check the adjustment values.

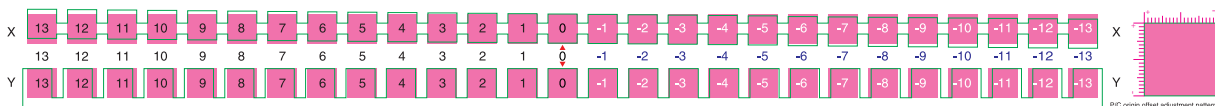

- (3) Input the numerical value of the position with the lowest vertical misalignment.

- Enter "-4" in the illustration shown below.

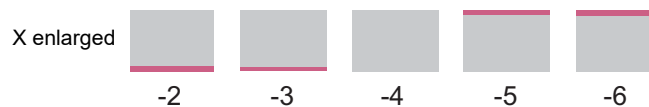

- (4) Input the numerical value of the position with the lowest horizontal misalignment.

- Enter "-2" in the illustration shown below.

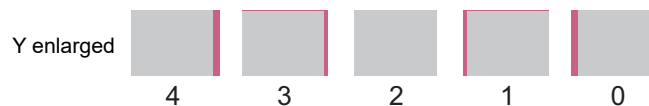

- With register marks

- (1) In REMOTE mode screen, select [AJUST].
- (2) Select [TP OFFSET], then press the [ENTER] key.







- The register marks are detected, and a correction pattern is cut. Detach the cut part of the pattern and check the adjustment values.
- The remaining steps are the same as those for "Without register marks".

7.2 Problems indicated by messages

If a problem occurs, the buzzer will sound, and a message will appear on the display. You can also use local guidance when checking.  ["Displaying Machine Information \(Local Guidance\)"\(P. 31\)](#)

Take appropriate measures based on the message. If a message is displayed again even after you take the recommended corrective action, contact your local dealer or our service office.

Warning messages

Message	Cause	Corrective action
MOTOR POWER OFF	<ul style="list-style-type: none"> The motor stops due to some action causing initialization—for example, opening the cover. 	<ul style="list-style-type: none"> Wait until the initialization operation is complete.
Replace NCU Ink Pad	<ul style="list-style-type: none"> The ink absorber needs to be replaced. 	<ul style="list-style-type: none"> The NCU ink absorber must be replaced. Contact your local distributor, our sales office, or service center.
NCU ERROR NozzleCheckOFF	<ul style="list-style-type: none"> An error occurred during the nozzle check. Printing stopped. The nozzle check function was disabled. 	<ul style="list-style-type: none"> Contact your local distributor, our sales office, or service center.
Nozzle Missing Detection Print Stopped	<ul style="list-style-type: none"> Nozzle clogging was detected. Printing stopped. 	<ul style="list-style-type: none"> Perform cleaning or change the conditions for the nozzle check function. If the message is displayed again, perform nozzle recovery.  "Head Cleaning"(P. 69)  "Nozzle Check Menu"(P. 122)  "Registering nozzle recovery"(P. 114)
Replace NCU	<ul style="list-style-type: none"> A problem was detected with the nozzle clogging assessment. 	<ul style="list-style-type: none"> The NCU must be replaced. Contact your local distributor, our sales office, or service center.
NCU Sensor Lv Low	<ul style="list-style-type: none"> The sensor's sensitivity is impaired. 	<ul style="list-style-type: none"> Clean the NCU.  "NCU Cleaning"(P. 135)
NCU Sens Adj Err H	<ul style="list-style-type: none"> Sensor sensitivity adjustment failed. 	<ul style="list-style-type: none"> Replace the NCU if the error does not clear. Contact your local distributor, our sales office, or service center.
NCU Sens Adj Err L		
NCU CONNECT	<ul style="list-style-type: none"> A problem was detected with the NCU connection. 	<ul style="list-style-type: none"> Turn off the power on the machine and turn it on after a while.  "Turning Off the Power"(P. 33)
NCU NZK CHK (HW) NozzleCheckOFF	<ul style="list-style-type: none"> A problem was detected with the nozzle clogging assessment. 	<ul style="list-style-type: none"> Clean the NCU.  "NCU Cleaning"(P. 135)
NCU NZK CHK (MARK) NozzleCheckOFF		
NCU CENTER POS NozzleCheckOFF	<ul style="list-style-type: none"> Printing position adjustment failed. 	
NCU FLUSH POS NozzleCheckOFF		
NCU SN Adjst	<ul style="list-style-type: none"> Sensor sensitivity adjustment failed. 	

Message	Cause	Corrective action
NozzleCheckOFF		
Ink Error	<ul style="list-style-type: none"> An ink error occurred. 	<ul style="list-style-type: none"> Check the ink error details. Ink errors (local guidance)
COVER OPEN	<ul style="list-style-type: none"> The cover is open. 	<ul style="list-style-type: none"> Close the cover.
Replace Cap Absorber	<ul style="list-style-type: none"> The capping count exceeded the preset value. 	<ul style="list-style-type: none"> Replace and clean the cap absorber, then reset the count. "Cap Absorber Replacement"(P. 147)
Lower the clamp lever	<ul style="list-style-type: none"> The clamp lever is raised. 	<ul style="list-style-type: none"> Lower the clamp lever. "Front"(P. 22)
Data Remain	<ul style="list-style-type: none"> Print (RIP) data was received. 	<ul style="list-style-type: none"> Switch to REMOTE mode and start printing or clear the data and abort printing.
Temporary Suspension	<ul style="list-style-type: none"> Printing has been paused. 	<ul style="list-style-type: none"> Switch to REMOTE mode and resume printing or clear the data and abort printing.
Printing not possible/ink IC	<ul style="list-style-type: none"> An unusable ink IC chip is used. 	<ul style="list-style-type: none"> Replace with new ink and a new ink IC chip.
NO MEDIA	<ul style="list-style-type: none"> No media is loaded, or the sensors are faulty. 	<ul style="list-style-type: none"> Load the media. "Loading the Media"(P. 57) Clean the media sensor. "Media Sensor Cleaning"(P. 141)
Please load media.	<ul style="list-style-type: none"> No media is loaded, or the sensors are faulty. 	<ul style="list-style-type: none"> Load the media. "Loading the Media"(P. 57)
No media detected	<ul style="list-style-type: none"> The media width has not been detected. 	<ul style="list-style-type: none"> Detect the media width. "Loading the Media"(P. 57)
Replace Wiper	<ul style="list-style-type: none"> The wiping count exceeded the preset value. 	<ul style="list-style-type: none"> Replace the wiper, then reset the count. "Wiper Replacement"(P. 146)
Wiper Move Failure	<ul style="list-style-type: none"> The wiper is not operating correctly. 	<ol style="list-style-type: none"> Clean the wiper and around the wiper. "Wiper Cleaning"(P. 132) Turn off the power on the machine and turn it on after a while. "Turning Off the Power"(P. 33)
Replace Waste ink tank	<ul style="list-style-type: none"> The waste ink tank count exceeded the preset value (90%). 	<p>Automatic maintenance is not possible while the covers are open. Perform the following steps:</p> <ol style="list-style-type: none"> Check the waste ink levels in the waste ink tank. "When "Check Waste Ink Tank" message appears"(P. 149) Replace the waste ink tank, then reset the waste ink level. "Replace the waste ink tank."(P. 149)
Check Waste Ink Tank	<ul style="list-style-type: none"> The waste ink tank count exceeded the preset value (80%). 	<ol style="list-style-type: none"> Check the waste ink levels in the waste ink tank. "When "Check Waste Ink Tank" message appears"(P. 149) Replace the waste ink tank, then reset the waste ink level. "Replace the waste ink tank."(P. 149)
High machine temp. ** ° C	<ul style="list-style-type: none"> Ambient temperatures are too high. 	<ul style="list-style-type: none"> Adjust ambient temperatures to temperatures within the specified range. Optimum print quality may not be

Message	Cause	Corrective action
Low machine temp. ** ° C	<ul style="list-style-type: none"> Ambient temperatures are too low. 	possible unless ambient conditions are within the specified range. Specifications
Perform an air purge.	<ul style="list-style-type: none"> The message is displayed every month to keep ink inside the ink routes from hardening. 	<ul style="list-style-type: none"> Perform an air purge. 🖨️ "Ink colors are mixed."(P. 163)

Ink errors (local guidance)









Message	Cause	Corrective action
Ink end	<ul style="list-style-type: none"> The ink has run out. 	<ul style="list-style-type: none"> Replace with new ink. 🖨️ "When Ink End is Displayed"(P. 41) If you use UISS, you may perform cleaning.
INK NEAR END	<ul style="list-style-type: none"> Ink levels are low. 	<ul style="list-style-type: none"> The ink will run out soon. Have new ink ready.
Non Ink IC	<ul style="list-style-type: none"> No ink IC chip was detected. 	<ol style="list-style-type: none"> Set the ink IC chip. Insert Ink IC Chip Check to confirm the ink IC chip was inserted correctly. Turn off the power on the machine and turn it on after a while. 🖨️ "Turning Off the Power"(P. 33)
Wrong Ink IC	<ul style="list-style-type: none"> An error occurred with the information on the ink IC chip. 	<ol style="list-style-type: none"> Check to confirm the ink IC chip was inserted correctly. Insert Ink IC Chip Turn off the power on the machine and turn it on after a while. 🖨️ "Turning Off the Power"(P. 33) Replace with new ink. 🖨️ "When Ink End is Displayed"(P. 41)
Ink Color	<ul style="list-style-type: none"> A different ink color is registered on the ink IC chip. 	<ul style="list-style-type: none"> Insert an ink IC chip for the correct ink color. Insert Ink IC Chip
Ink Type	<ul style="list-style-type: none"> A different ink type is registered on the ink IC chip. 	<ul style="list-style-type: none"> Insert an ink IC chip for the correct ink type. Insert Ink IC Chip
Expiration	<ul style="list-style-type: none"> The ink has expired. 	<ul style="list-style-type: none"> Replace with new ink or use up as quickly as possible. Printing is possible. 🖨️ "When Ink End is Displayed"(P. 41)
Expiration:1MONTH	<ul style="list-style-type: none"> The ink is one month past its expiration date and cannot be used. 	<ul style="list-style-type: none"> Replace with new ink or use up as quickly as possible. Printing is possible. 🖨️ "When Ink End is Displayed"(P. 41)
Expiration:2MONTH	<ul style="list-style-type: none"> The ink is two months past its expiration date and cannot be used. 	<ul style="list-style-type: none"> Replace with new ink. Printing is not possible. 🖨️ "When Ink End is Displayed"(P. 41)

Error messages









Error number	Message	Cause	Corrective action
04	PARAM ROM	<ul style="list-style-type: none"> A problem was detected with the main PCB. 	<ul style="list-style-type: none"> Turn off the power on the machine and turn it on after a while. 🧐 "Turning Off the Power"(P. 33)
108	HD THERMIS [1234]	<ul style="list-style-type: none"> A problem was detected with print head temperature control. 	<ul style="list-style-type: none"> Turn off the power on the machine and turn it on after a while. 🧐 "Turning Off the Power"(P. 33)
108	HD CONNECT [1234]	<ul style="list-style-type: none"> A problem was detected with the print head connection. 	
108	HD MEM EMP [1234]	<ul style="list-style-type: none"> A problem was detected with the print head. 	
108	HD TYPE [1234]		
122	CHECK:SDRAM	<ul style="list-style-type: none"> A problem was detected with the SDRAM. 	<ul style="list-style-type: none"> Turn off the power on the machine and turn it on after a while. 🧐 "Turning Off the Power"(P. 33)
128	HDC FIFO OVER	<ul style="list-style-type: none"> A problem was detected with the print head control PCB. 	
128	HDC FIFO UNDER		
129	Battery Exchange	<ul style="list-style-type: none"> The internal clock battery is spent and must be replaced. 	<ul style="list-style-type: none"> Contact your local distributor, our sales office, or service center.
12a	HDC SPEED	<ul style="list-style-type: none"> A problem was detected with the print head control. 	<ul style="list-style-type: none"> Turn off the power on the machine and turn it on after a while. 🧐 "Turning Off the Power"(P. 33)
130	HD DATA SEQ		
148	E-LOG SEQ	<ul style="list-style-type: none"> A problem was detected with log control. 	<ul style="list-style-type: none"> Turn off the power on the machine and turn it on after a while. 🧐 "Turning Off the Power"(P. 33)
151	Main PCB V1R2	<ul style="list-style-type: none"> A problem was detected with the main PCB power supply circuit. 	<ul style="list-style-type: none"> Turn off the power on the machine and turn it on after a while. 🧐 "Turning Off the Power"(P. 33)
152	Main PCB V2R5		
153	Main PCB V3R3		
154	Main PCB V05		
155	Main PCB V36-1		
157	Main PCB VTT		
158	Main PCB V36-2		
15f	HEAD DRIVE HOT	<ul style="list-style-type: none"> The COM drive has overheated. 	<ul style="list-style-type: none"> Turn off the power on the machine and turn it on after a while. 🧐 "Turning Off the Power"(P. 33)
16e	Main PCB V3R3B	<ul style="list-style-type: none"> A problem was detected with the main PCB power supply circuit. 	
171	NEW HEAD CONNECT	<ul style="list-style-type: none"> A new print head connection was detected. 	
18a	Main PCB V_CORE	<ul style="list-style-type: none"> A problem was detected with the main PCB power supply. 	<ul style="list-style-type: none"> Turn off the power on the machine and turn it on after a while. 🧐 "Turning Off the Power"(P. 33)
18b	Main PCB V1R5B		
18c	Main PCB V12		



Error number	Message	Cause	Corrective action
18e	FLS NOT COMP	<ul style="list-style-type: none"> A problem was detected with the print head control. 	<ul style="list-style-type: none"> Turn off the power on the machine and turn it on after a while. "Turning Off the Power"(P. 33)
18f	OFSET START		
18f	OFSET END		
19f	LED CONNECT	<ul style="list-style-type: none"> The UV-LED PCB could not be detected. 	<ul style="list-style-type: none"> Turn off the power on the machine and turn it on after a while. "Turning Off the Power"(P. 33)
1dc	Station4 PCB V24	<ul style="list-style-type: none"> A problem was detected with the Station4 PCB power supply. 	<ul style="list-style-type: none"> Turn off the power on the machine and turn it on after a while. "Turning Off the Power"(P. 33)
1dd	Station4 PCB V24-A		
1e6	PRAM Size Shortage	<ul style="list-style-type: none"> Insufficient memory 	<ul style="list-style-type: none"> Turn off the power on the machine and turn it on after a while. "Turning Off the Power"(P. 33)
201	Command Error	<ul style="list-style-type: none"> Data other than print (RIP) data was received, or a problem was detected with the print (RIP) data received. 	<ol style="list-style-type: none"> Clear the data and resend. Check the USB cable connection. "Using a USB 2.0 Interface Cable"(P. 34) Use a compliant USB cable. "USB 2.0 Interface Precautions"(P. 34) Turn off the power on the machine and turn it on after a while. "Turning Off the Power"(P. 33)
202	Parameter Error	<ul style="list-style-type: none"> A problem was detected with the print (RIP) data received. 	
206	Printing Mode	<ul style="list-style-type: none"> Print (RIP) data was received with print parameters that do not allow printing. 	<ul style="list-style-type: none"> Change the output parameters and profile using RIP software.
20A	Driver version	<ul style="list-style-type: none"> Printing is not possible because the Mimaki driver version is old. 	<ul style="list-style-type: none"> Install the latest Mimaki driver available from: https://mimaki.com/download/inkjet.html
304	USB INIT ERR	<ul style="list-style-type: none"> A problem was detected with the USB cable connection. 	<ol style="list-style-type: none"> Check the USB cable connection. "Using a USB 2.0 Interface Cable"(P. 34) Use a compliant USB cable. "USB 2.0 Interface Precautions"(P. 34) Turn off the power on the machine and turn it on after a while. "Turning Off the Power"(P. 33)
305	USB TIME OUT		
307	MCFD File IF Error	<ul style="list-style-type: none"> A problem was detected while accessing print parameter data. 	<ul style="list-style-type: none"> Turn off the power on the machine and turn it on after a while. "Turning Off the Power"(P. 33)
401	Motor X	<ul style="list-style-type: none"> The X motor was overloaded. 	<ol style="list-style-type: none"> Check to confirm the media is loaded correctly. "Loading the Media"(P. 57) Open the front cover and check for anything that may obstruct carriage movement. Turn off the power on the machine and turn it on after a while. "Turning Off the Power"(P. 33)
402	Motor Y	<ul style="list-style-type: none"> The Y motor was overloaded. 	
403	X Current	<ul style="list-style-type: none"> An overcurrent was detected in the X motor. 	
404	Y Current	<ul style="list-style-type: none"> An overcurrent was detected in the Y motor. 	

Error number	Message	Cause	Corrective action
44e	UV Unit Fan Error	<ul style="list-style-type: none"> A problem was detected with the UV-LED unit fan. 	<ul style="list-style-type: none"> Turn off the power on the machine and turn it on after a while. "Turning Off the Power"(P. 33)
44f	Take-up Roll Sns Err	<ul style="list-style-type: none"> A problem was detected with the take-up unit sensor spindle. 	<ol style="list-style-type: none"> Check to confirm the [Machine Setup] > [Feeding/Take-up] > [Take-up Unit] setting is "ON". Check to confirm the media is loaded correctly. "Loading the Roll Media"(P. 57) Check to confirm the take-up unit switch functions properly. "Take-up Unit"(P. 26)
45a	P-HEAD TAKE OFF Err	<ul style="list-style-type: none"> The carriage could not be disconnected. 	<ul style="list-style-type: none"> Turn off the power on the machine and turn it on after a while. "Turning Off the Power"(P. 33)
45b	P-HEAD Connct Err	<ul style="list-style-type: none"> Unable to connect to carriage 	
45c	C-HEAD TAKE OFF Err	<ul style="list-style-type: none"> The cutter head could not be disconnected. 	
45d	C-HEAD Connct Err	<ul style="list-style-type: none"> Unable to connect to cutter head 	
45e	CHECK PR/GR POSITION	<ul style="list-style-type: none"> A problem was detected with the pinch roller positions. 	<ul style="list-style-type: none"> Place the pinch rollers above the grid rollers.
48a	Detect winding failure	<ul style="list-style-type: none"> The take-up unit is unable to take up media. 	<ul style="list-style-type: none"> Check to confirm the media is loaded correctly. "Loading the Roll Media"(P. 57)
504	CLAMP UP	<ul style="list-style-type: none"> The clamp lever is lifted. 	<ul style="list-style-type: none"> Lower the clamp lever.
505	Media Jam	<ul style="list-style-type: none"> The media jam sensor was triggered. 	<ol style="list-style-type: none"> Remove the media in contact with the carriage and reload with fresh media. "Loading the Media"(P. 57) Open the front cover and check for anything that may obstruct carriage movement.
509	HDC POSCNT	<ul style="list-style-type: none"> A problem was detected with position control. 	<ul style="list-style-type: none"> Turn off the power on the machine and turn it on after a while. "Turning Off the Power"(P. 33)
50a	Y Org Detect Error	<ul style="list-style-type: none"> A problem was detected with Y origin detection (initialization). 	
50c	Media Width Sensor	<ul style="list-style-type: none"> A problem was detected with media width detection. 	<ol style="list-style-type: none"> Check the media loading position. "Loading the Media"(P. 57) Clean the media width sensor. "Media Sensor Cleaning"(P. 141)
50f	L-SCALE BLACK	<ul style="list-style-type: none"> A problem was detected with the linear scale. 	<ul style="list-style-type: none"> Turn off the power on the machine and turn it on after a while. "Turning Off the Power"(P. 33)
516	Media Set Position R	<ul style="list-style-type: none"> The media was loaded outside the range of valid positions. 	<ol style="list-style-type: none"> Check the media loading position. "Loading the Media"(P. 57) Clean the media width sensor. "Media Sensor Cleaning"(P. 141)



Error number	Message	Cause	Corrective action
519	NEGATIVE P.SENSOR	<ul style="list-style-type: none"> Negative pressure sensor automatic recognition failed. 	<ul style="list-style-type: none"> Turn off the power on the machine and turn it on after a while.  "Turning Off the Power"(P. 33)
521	CHECK JOINT SENSOR	<ul style="list-style-type: none"> A failure occurred while connecting the cutter head and the connecting unit. 	
522	CUT HOME POSITION	<ul style="list-style-type: none"> The cutter head could not be moved due to a connection failure between the cutter head and the connecting unit. 	
523	CHECK PR SENSOR	<ul style="list-style-type: none"> The pinch roller position detection failed. 	
525	Wrong Ionizer	<ul style="list-style-type: none"> The ionizer internal circuit is defective, or an abnormal discharge occurred. 	<ul style="list-style-type: none"> Turn off the power on the machine and turn it on after a while.  "Turning Off the Power"(P. 33)
526	Ionizer Ion Level	<ul style="list-style-type: none"> The amount of generated ions was reduced by fouling and abrasion of the electrode needle. 	<ul style="list-style-type: none"> Refer to the instruction manual for the ionizer and clean the electrodes.
527	Ionizer Condition	<ul style="list-style-type: none"> Ambient conditions may cause ions to be absorbed by metals in the vicinity and affect discharge capability. 	<ul style="list-style-type: none"> Remove any conductors or discharge devices close to the ionizer.
528	Pump Motor Sensor	<ul style="list-style-type: none"> A problem was detected with the pump motor. 	<ul style="list-style-type: none"> Turn off the power on the machine and turn it on after a while.  "Turning Off the Power"(P. 33)
549	LEnc. Count DIO	<ul style="list-style-type: none"> A problem was detected with the linear scale wiring to the DIO PCB. 	<ul style="list-style-type: none"> Turn off the power on the machine and turn it on after a while.  "Turning Off the Power"(P. 33)
551	HDC DIO LENC count	<ul style="list-style-type: none"> A problem was detected with the HDC and DIO board encoder values. 	<ul style="list-style-type: none"> Turn off the power on the machine and turn it on after a while.  "Turning Off the Power"(P. 33)
607	Replace Cap Absorber	<ul style="list-style-type: none"> The capping count exceeded the preset value. 	<ul style="list-style-type: none"> Replace and clean the cap absorber, then reset the count.  "Cap Absorber Replacement"(P. 147)
608	Wrong Ink IC	<ul style="list-style-type: none"> An error occurred with the information on the ink IC chip. 	<ol style="list-style-type: none"> Check to confirm the ink IC chip was inserted correctly. Turn off the power on the machine and turn it on after a while.  "Turning Off the Power"(P. 33) Replace with new ink.
61a	InkOverflow	<ul style="list-style-type: none"> The sub tank float sensor detected the limit. 	<ul style="list-style-type: none"> Execute [MAINTENANCE] > [Overflow].
61b	Ink Supply	<ul style="list-style-type: none"> A failure occurred while supplying ink to the sub tank. 	<ul style="list-style-type: none"> Turn off the power on the machine and turn it on after a while.  "Turning Off the Power"(P. 33)

Error number	Message	Cause	Corrective action
61d	NEGATIVE P. NotEnough	<ul style="list-style-type: none"> The required negative pressure cannot be maintained. (On the positive side) 	
61e	NEGATIVE P. OVER	<ul style="list-style-type: none"> The required negative pressure cannot be maintained. (On the negative side) 	
620	POSITIVE P. NotEnough	<ul style="list-style-type: none"> The required positive pressure cannot be maintained. (On the negative side) 	
621	POSITIVE P. OVER	<ul style="list-style-type: none"> The required positive pressure cannot be maintained. (On the positive side) 	
627	INK BOTTLE SET	<ul style="list-style-type: none"> The ink IC chip could not be read for a certain period of time. 	<ol style="list-style-type: none"> Check to confirm that the IC chip was inserted correctly. Insert Ink IC Chip Turn off the power on the machine and turn it on after a while. 🛠️ "Turning Off the Power"(P. 33)
64C	NCU Error	<ul style="list-style-type: none"> The function is disabled due to an error. 	<ul style="list-style-type: none"> Turn off the power on the machine and turn it on after a while. 🛠️ "Turning Off the Power"(P. 33)
650	NCU CONNECT	<ul style="list-style-type: none"> A problem was detected with the NCU connection. 	
651	Replace NCU	<ul style="list-style-type: none"> A problem was detected with the nozzle clogging assessment. 	<ul style="list-style-type: none"> The NCU must be replaced. Contact your local distributor, our sales office, or service center.
652	NCU NZK CHK (HW)	<ul style="list-style-type: none"> A problem was detected with the nozzle clogging assessment. 	<ul style="list-style-type: none"> Clean the NCU. 🛠️ "NCU Cleaning"(P. 135)
653	NCU NZK CHK (Mark)		
654	NCU CENTER POS		
655	NCU FLUSH POS	<ul style="list-style-type: none"> Printing position adjustment failed. 	
656	NCU SN Adjst	<ul style="list-style-type: none"> Sensor sensitivity adjustment failed. 	
657	Replace NCU Ink Pad	<ul style="list-style-type: none"> The NCU ink absorber is full. 	<ul style="list-style-type: none"> The NCU ink absorber must be replaced. Contact your local distributor, our sales office, or service center.
658	NCU Sensor Lv Low	<ul style="list-style-type: none"> The sensor's sensitivity is impaired. 	<ul style="list-style-type: none"> Clean the NCU. 🛠️ "NCU Cleaning"(P. 135) Replace the NCU if the error does not clear. Contact your local distributor, our sales office, or service center.
65b	NCU Sens Adj Err H	<ul style="list-style-type: none"> Sensor sensitivity adjustment failed. 	
65c	NCU Sens Adj Err L		
715	InkHeater Thr	<ul style="list-style-type: none"> A problem was detected with the ink heater thermistor. 	<ul style="list-style-type: none"> Turn off the power on the machine and turn it on after a while. 🛠️ "Turning Off the Power"(P. 33)
716	InkHeater Tmp		
717	InkHeater Brk		

Error number	Message	Cause	Corrective action
71a	UV-DRV Fuse	<ul style="list-style-type: none"> A UV-DRV PCB fuse blew. 	
901	INVALID OPERATE	<ul style="list-style-type: none"> The function is disabled due to an error. 	<ul style="list-style-type: none"> Check the error details.
902	Data Remain	<ul style="list-style-type: none"> Print (RIP) data was received. 	<ul style="list-style-type: none"> Switch to REMOTE mode and start printing or clear the data and abort printing.
90d	No Head Select	<ul style="list-style-type: none"> A problem was detected with the print head. 	<ul style="list-style-type: none"> Turn off the power on the machine and turn it on after a while.  "Turning Off the Power"(P. 33)
90f	Print Area Short	<ul style="list-style-type: none"> The media is too small for the print. 	<ul style="list-style-type: none"> Replace with wider or longer media. If the printable area is reduced due to a shift in the origin, move the origin to increase the size of the printable area.
b0a	CTC PCB Vpow	<ul style="list-style-type: none"> A problem was detected with the CTC PCB power supply voltage. 	<ul style="list-style-type: none"> Turn off the power on the machine and turn it on after a while.  "Turning Off the Power"(P. 33)
b0b	CTC PCB V24		
b0c	CTC PCB V5R0		
b0d	CTC PCB V3R3		
b0e	CTC PCB V2R5		
b0f	DIO PCB Uvpow	<ul style="list-style-type: none"> A problem was detected with the UV-DRV PCB power supply voltage. 	<ul style="list-style-type: none"> Turn off the power on the machine and turn it on after a while.  "Turning Off the Power"(P. 33)
b19	Station4 PCB V36	<ul style="list-style-type: none"> A problem was detected with the station IV PCB power supply. 	<ul style="list-style-type: none"> Turn off the power on the machine and turn it on after a while.  "Turning Off the Power"(P. 33)
C10	COMMAND	<ul style="list-style-type: none"> Received a code other than a COMMAND code. 	<ol style="list-style-type: none"> Clear the data and resend. Turn off the power on the machine and turn it on after a while.  "Turning Off the Power"(P. 33) Check the USB cable connection.  "Using a USB 2.0 Interface Cable"(P. 34) Use a compliant USB cable.  "USB 2.0 Interface Precautions"(P. 34)
C11	PARAMETER	<ul style="list-style-type: none"> Received parameter outside numerical value range 	
C12	DEVICE	<ul style="list-style-type: none"> Received an invalid device control command. 	
C31	NO DATA	<ul style="list-style-type: none"> "COPY" was executed, but no data is saved to the receive buffer. 	<ul style="list-style-type: none"> Cut the same data once more.
C32	DATAtooBIG	<ul style="list-style-type: none"> The received data is too big for multiple sheet cutting. 	<ul style="list-style-type: none"> Change the data size.
C33	SHEET SIZE	<ul style="list-style-type: none"> The sheet is too short in the feed direction. 	<ul style="list-style-type: none"> Use a longer sheet.
C36	TP DETECT	<ul style="list-style-type: none"> Unable to detect register marks 	<ol style="list-style-type: none"> Check to confirm the register marks are placed properly.  "Register marks"(P. 98) Load the uncurled media. Check the mark detection start position.

Error number	Message	Cause	Corrective action
			<ol style="list-style-type: none"> 4. Check to confirm the register marks are black and printed on a white background. 5. Check to confirm the area between the register marks is clean and free of print. 6. Check to confirm there are no errors in the mark detection settings. 7. If the area around the register marks is filled in, set [TP DETECT] > [MARK FILLUP] setting to "ON".
C37	MARK ORG	<ul style="list-style-type: none"> • The mark detection result shows that the register marks were detected outside the plotting range. 	<ul style="list-style-type: none"> • Change the layout by referring to the following:  "Reading Range of Register Marks"(P. 100)
C60	PenEncoder	<ul style="list-style-type: none"> • Unable to detect pen height 	<ul style="list-style-type: none"> • Turn off the power on the machine and turn it on after a while.  "Turning Off the Power"(P. 33)
C61	Pen Stroke	<ul style="list-style-type: none"> • The pen height is incorrect. 	<ol style="list-style-type: none"> 1. Make sure the pen line rubber is not worn or deformed and remains intact. 2. Check to confirm nothing adheres to the pen line rubber. 3. After installing the pen in a commercially available pen holder, check to confirm the installed position is correct.

SYSTEM HALT

Error number	Message	Corrective action
000	Message	<ul style="list-style-type: none"> • Turn off the power on the machine and turn it on after a while.  "Turning Off the Power"(P. 33)
406	WIPER ORG	<ol style="list-style-type: none"> 1. Clean the wiper and around the wiper.  "Wiper Cleaning"(P. 132) 2. Turn off the power on the machine and turn it on after a while.  "Turning Off the Power"(P. 33)

Chapter 8 Appendix



This chapter

This chapter explains the specifications of this machine.

Specifications	184	LICENSE Library	188
Specifications (Cutting)	187		

8.1 Specifications

Item		UCJV300				UCJV150	
		160	130	107	75	160	
Print head	Type	Drop-on-demand piezoelectric print heads					
	Specifications	Two inline heads with 4 rows				One head with 4 rows	
	Resolution	Y: 300 dpi, 600 dpi, 1,200 dpi X: 600 dpi, 900 dpi, 1,200 dpi					
Ink set	4-color	C, M, Y, K (UISS functions on all)				C, M, Y, K	
	4-color, W	C, M, Y, K, W (UISS functions only on C and M)				-	
	4-color, W, CL	C, M, Y, K, W, CL (UISS functions only on W and CL)				-	
	6-color, W	C, M, Y, K, Lc, Lm, W				-	
Media	Type	Label paper (paper base), PVC sheet (not more than 0.25 mm in thickness, including laminating layer), fluorescent sheet, reflective sheet (excluding high-luminosity reflective sheet)					
	Maximum printing/cut width ^{*1}	1,610 mm	1,361 mm	1,090 mm	800 mm	1,610 mm	
	Common for roll/leaf	Maximum width	1,620 mm	1,371 mm	1,100 mm	810 mm	1,620 mm
		Minimum width	210 mm				
		Thickness	Max. 1.0 mm				
	Roll	Roll external diameter ^{*2}	Max. 250 mm (paper media), max. 210 mm (other media)				
		Roll weight ^{*2, *3}	Max. 40 kg				
		Core internal diameter ^{*4}	2 inches or 3 inches				
		Printing face	Exterior/interior				
		Roll end	Taped or loosely affixed to core				
	Print margins	Left/right	15.0 mm (default), minimum: Left/right 5 mm				
Top end		120 mm					
Bottom end		150 mm					
Distance accuracy ^{*5}	Absolute accuracy	±0.3 mm or ±0.3 % of specified distance, whichever is greater					
	Duplicability	±0.2 mm or ±0.1 % of specified distance, whichever is greater					
Perpendicularity	±0.5 mm/1,000 mm						
Media skew	Not more than 5 mm/10 m						
Printing gap	Manual, three settings (2.0, 2.5, 3.0 mm)						
Media cutting	Cutting precision (steps): Not more than 0.5 mm						

Item		UCJV300				UCJV150
		160	130	107	75	160
Origin alignment		LED pointer				
Ink supply		Ink bottle				
Washing liquid feed		N/A				
Waste ink tank		Bottle type (2,000 ml)				
Take-up units		Selectable inside/outside winding				
Media heater		N/A				
NCU (Nozzle clogging detection)		Provided				
UV unit		Air-cooled LED UV emitters x2				
Image buffer		SD-RAM: 2 GB				
Interface	Data transfer function	USB 2.0 Hi-speed, Ethernet 1000BASE-T				
	Email function	Ethernet 10BASE-T/100BASE-TX/1000BASE-T				
Commands		MRL-V				
Languages		English, Japanese, Chinese, Turkish, Portuguese				
Noise levels	At standby	Not more than 55 dB (FAST-A, 1 m on all sides)				
	Continuous operation	Not more than 65 dB				
	Non-continuous operation	Not more than 70 dB				
Compliance with standards		VCCI Class A, FCC Class A, IEC 62368-1 ETL compliance, CE marking (EMC Directive, Low Voltage Directive, Machinery Directive), CB certified, RoHS, REACH, EnergyStar, RCM marking				
Power supply specifications ^{*6}		Single-phase 100 to 120 V AC $\pm 10\%$ /12 A, single-phase 200 to 240 V AC $\pm 10\%$ /8 A, 50/60 Hz ± 1 Hz				
Power consumption	Normal	-				
	Max.	1,440 W (100 to 120 V AC), 1,920 W (200 to 240 V AC)				
	Min.	-				
Installation environment ^{*7}	Permissible ambient temperature	20 to 30 °C				
	Relative humidity	35 to 65 %RH (no condensation)				
	Temperature range in which accuracy is guaranteed	20 to 25°C				
	Temperature gradient	Not more than ± 10 °C/h				
	Dust	0.15 mg/m ³ (typical office)				
	Maximum operating altitude	2,000 m				
External dimensions ^{*8}	Width	2,900 mm (- mm)	2,650 mm (- mm)	2,380 mm (- mm)	2,090 mm (- mm)	2,900 mm (- mm)
	Depth	776 mm (- mm)				
	Height ^{*Excluding ink bottle}	1,475 mm (xxxx mm)				

Item	UCJV300				UCJV150
	160	130	107	75	160
Weight ^{*8}	188 kg (- kg)	177 kg (- kg)	161 kg (- kg)	144 kg (- kg)	183 kg (- kg)

- *1. Setup menu margins set to the minimum (5 mm) on either side
- *2. External diameter and weight after winding media
- *3. Free of sagging due to weight
- *4. 3 inch only for high-speed printing
- *5. Excluding media size variation and fluctuations at initial loading
- *6. Excluding options
- *7. Ink printing consistency will decrease in conditions outside this range.
- *8. The figures in parentheses indicate package dimensions.

8.2 Specifications (Cutting)

Item	Details
Maximum speed ^{*1}	30 cm/s (42 cm/s at 45°)
Maximum acceleration	0.5 G
Cut pressure	10 to 450 g
Cutter response count	10 times/second
Usable tools	Eccentric cutter, ballpoint pen (commercially sold) ^{*2}
Usable media	Label paper (paper base), PVC sheet ^{*3} (not more than 0.25 mm thick, including lamination), fluorescent sheet ^{*4} , reflective sheet ^{*4} (excluding high-luminosity reflective sheet)
Repetition accuracy	±0.2 mm or less (excluding expansion and contraction due to temperature)
Receive buffer memory	32 MB
Commands	MGL-II c2
Program steps	25 μm/step

*1. Depending on media size, the maximum speed may be limited. It is not possible to operate at both maximum speed and maximum acceleration.

*2. Use one free of protrusions and tapers on the clamped part. Depending on the ballpoint pen, optimal image quality may not be possible.

*3. When using our specified sheet

*4. When using fluorescent sheet blade (SPB-0007) or reflective sheet blade (SPB-0006)

8.3 LICENSE Library

Mimaki printer Firmware

Copyright ©2020 MIMAKI ENGINEERING CO.,LTD. All rights reserved.

This product contain open source software listed in the tables below.

Component	License
StarterWare for ARM® based TI Sitara Processors	BSD-TI

The following license terms and conditions shall apply to the open source software listed in the table above:

BSD-TI

Copyright (C) 2010 Texas Instruments Incorporated - <http://www.ti.com/>

Redistribution and use in source and binary forms, with or without modification, are permitted provided that the following conditions are met:

1. Redistributions of source code must retain the above copyright notice, this list of conditions and the following disclaimer.
2. Redistributions in binary form must reproduce the above copyright notice, this list of conditions and the following disclaimer in the documentation and/or other materials provided with the distribution.
3. Neither the name of Texas Instruments Incorporated nor the names of its contributors may be used to endorse or promote products derived from this software without specific prior written permission.

THIS SOFTWARE IS PROVIDED BY THE COPYRIGHT HOLDERS AND CONTRIBUTORS "AS IS" AND ANY EXPRESS OR IMPLIED WARRANTIES, INCLUDING, BUT NOT LIMITED TO, THE IMPLIED WARRANTIES OF MERCHANTABILITY AND FITNESS FOR A PARTICULAR PURPOSE ARE DISCLAIMED. IN NO EVENT SHALL THE COPYRIGHT OWNER OR CONTRIBUTORS BE LIABLE FOR ANY DIRECT, INDIRECT, INCIDENTAL, SPECIAL, EXEMPLARY, OR CONSEQUENTIAL DAMAGES (INCLUDING, BUT NOT LIMITED TO, PROCUREMENT OF SUBSTITUTE GOODS OR SERVICES; LOSS OF USE, DATA, OR PROFITS; OR BUSINESS INTERRUPTION) HOWEVER CAUSED AND ON ANY THEORY OF LIABILITY, WHETHER IN CONTRACT, STRICT LIABILITY, OR TORT (INCLUDING NEGLIGENCE OR OTHERWISE) ARISING IN ANY WAY OUT OF THE USE OF THIS SOFTWARE, EVEN IF ADVISED OF THE POSSIBILITY OF SUCH DAMAGE.

Index

Icons

[END/POWER] key	27, 28, 33
[ENTER] key	28
[FUNCTION] key	28, 30
[JOG] key	28
[SEL] key	28

A

AC inlet	23
ADJ-PRS OFFSET	126, 170
Air purge	114
Auto Cleaning	111
Auto Maint.	114
AUTO MEDIA CUT	127
Auto Nozzle Recovery	122
Auto Power-off	117

C

Cancel	28
Cap	131, 134
Cap absorber	147
Capping station	22, 24
Carriage	22, 24, 131, 136
Carriage movement	28
Carriage Out	113
Clamp lever	22, 23
Cleaning Check	111
Color profile	38
COPY	125, 127, 180
CORNER CUT	126, 128
CURVE MODE	126
Custody Wash	113, 143
CUT MODE	125
Cutter unit	22
Cutting Menu	124
Cutting slot	24

D

DETECT AREA	125
-------------------	-----

DETECT END KEY START.....	125
Disclaimers	6
Display.....	28, 29
Display language.....	118
Drop.PosCorrect.....	30, 49, 72, 109
DRYING TIME.....	110
DUMMY CUT.....	126

E

Error.....	28
Error History	123
Event Mail.....	118, 120
Exhaust fan BOX.....	131, 151
Exhaust fan filter.....	131, 151

F

FCC regulations	7
Feed Comp.....	30, 49, 70, 109
Feed Speed.....	110
Feed unit	23
FILL UP INK	114
FineCut.....	102

G

Grid rollers.....	22, 25, 52
-------------------	------------

H

Half cut	90, 158
Head cleaning	28, 69
Head height	51
Head Maint.	113
Height adjustment lever.....	51

I

ID Cut	101, 105
ID Cut Guide.....	101, 105
Information menu	123
Ink discharge channel	131, 140
Ink end.....	41
Ink error	29
Ink expiration date	13
Ink IC chip	45

Ink IC chip slot.....	22
Ink level	29
Ink near-end	41
Ink REPL.Report	123
Ink status	29
Ink status indicator lamp.....	25
Ink status lamp	22
Ink supply unit	22, 25, 45
Ink wipe filter	22, 23
Inlet.....	32
Installation guide	38, 39
Installation Space	16
Interference	6
Interval Wiping.....	111
Ionizer.....	111
<hr/> J <hr/>	
Judgment Condition	122
<hr/> K <hr/>	
Key Buzzer	118
<hr/> L <hr/>	
LAN cable	34
LAN port	23
LANGUAGE	118
Leaf media.....	62
List.....	123
Local guidance	31
LOCAL mode.....	28, 29
Logical Seek	109
LT Mode	111, 112
<hr/> M <hr/>	
Machine setup menu	117
Main power supply switch	23, 26, 32
Maintenance covers	22
Maintenance menu	113
MAPS	111
Margin	100, 110
MARK FILLUP.....	125
MARKS SENSOR	126, 167, 168, 169

Media.....	57
Media Detect	117
Media feed.....	28
Media hanger	58
Media holder.....	131, 142
Media Remain	117
Media sensor.....	23, 26, 131, 141
MENU mode.....	29
menu modes.....	29
Mist filter	131, 138, 155
Multilayer printing	66

N

NCU.....	24, 131, 135
Network	118
NOT-READY mode	29
Nozzle check menu	122
Nozzle Recovery	114
Nozzle Wash	113, 139

O

Offset.....	90
Operating panel.....	22, 28
OVER CUT	126, 127
OVER PRINT.....	110
Overflow	114

P

Pen line	158
Pinch roller guide.....	52
Pinch rollers.....	22, 25, 48, 52, 66, 80, 152
Platen	22, 24, 131, 142
Power cable.....	32
Power outlet	32
Power plug	32
Power Supply Switch.....	26
Print Area	123
Print Length	123
Print origin	75
Printing Check	122
Pump tube cleaning.....	113

R

RasterLink	38, 39, 40, 73, 74, 100, 101, 102, 110, 167, 170
Receive buffer	76, 93, 125, 127, 167, 180
Reference guide	40, 74
Register mark	96, 98, 99, 102, 124
Register mark detection	98, 100, 101, 103, 104
REMOTE mode	28, 29
Replace Cap Absorber	147
Replace Waste ink tank	114
Replace Wiper	113, 146
Roll holder	58
Roll media	58

S

Safety Interlocks	18
SAMPLE CUT	126, 167, 170
SCALE ADJUST	127, 168
SENSOR LEVEL	125, 172, 179
Setup menu	108
SETUP SUB MENU	125
SHEET TYPE	126
Smoothing Level	111
Space Feed Mode	118
Station	113
Status lamp	28
Switching hub	36
Symbols	8
SYSTEM HALT	28

T

Take-up SW	117
Take-up unit	22, 26, 117
Temporary	108
Test printing	28, 67
Time Set	118
TOOL CHANGE	84, 88, 125, 155
Torque limiter	62
TP DETECT	124, 180, 181

U

UNIT / LENGTH	118
UNIT / TEMP	118

UP SPEED	125
Usage	123
USB 2.0 interface cable	34
USB driver	37
USB port	23
Use Time	123
UV AdjVal	111
UV Lamp	123
UV mode	111
UV-LED lamp	131, 137

V

Vacuum	23, 110, 126
Version	123
View Feed	118

W

Warning Labels	19
Waste ink tank	22, 123, 131, 148
White ink	67
Wiper	131, 132, 146
Wiping	123

Operation manual

September, 2020

MIMAKI ENGINEERING CO.,LTD.

2182-3 Shigeno-otsu, Tomi-shi, Nagano 389-0512 JAPAN

D203176-26-24092020

